

CATALOGUE/CATÁLOGO

WOOD LINE
LINEA MADERA

ATELIER LINE
GAMA LABORATORIO

CONSTRUCTION RANGE
GAMA DE CONSTRUCTION

METAL WORKING
TRABAJO DE METAL

20
24



POWER TO IMAGINATION



The Job Line world: Everything you want for your professional laboratory!

FEMI Job Line products are the ideal choice for all daily work needs and to give space to your creativity

A range which, over time, has been completed, enriched with new features, expanding the solutions and offers with reliable and safe products for cutting, working and finishing wood and metal.

The **Job Line** brand turns 25 and is continuously expanding on the international market and considered a reliable and quality partner for professional users and DIY!

The products of the **Job Line** are chosen, tested and guaranteed by **FEMI SpA**, an Italian company that is the leader in the world of professional and industrial machines for over 55 years.



*El mundo **Job Line**: ¡Todo lo que deseas para tu laboratorio profesional!*

*Los productos **FEMI Job Line** son la opción ideal para todas las necesidades laborales diarias y para dar espacio a su creatividad.*

Una gama que, con el tiempo, se ha ido completando, enriqueciendo con nuevas funcionalidades, ampliando las soluciones y ofertas con productos fiables y seguros para el corte, el trabajo y el acabado de la madera y el metal.

*¡La marca **Job Line** cumple 25 años y se expande continuamente en el mercado internacional y es considerada un socio fiable y de calidad para los usuarios profesionales y el bricolaje!*

*Los productos de **Job Line** son elegidos, probados y garantizados por **FEMI SpA**, empresa italiana líder en el mundo de las máquinas profesionales e industriales desde hace más de 55 años.*



POWER TO IMAGINATION

INDEX | ÍNDICE

WOOD LINE | LINEA MADERA

MITRESAWS TRONZADORAS DE MADERA	4-13
SLIDE COMPOUND MITRESAWS TRONZADORAS DE MADERA TELESCOPICA.....	14-16
TABLE ROUTER FRESADORA DE BANCO.....	17
VERTICAL BANDSAWS SIERRAS DE CINTA	18-22
PLANER THICKNESSER CEPILLADORAS REGRUESADORAS.....	23-26
COMBINED MACHINE MAQUINA COMBINADA	27
CYCLONE DUST COLLECTORS ASPIRADORES DE CICLO	28-29
CIRCULAR BLADES DISCOS	30
ACCESSORIES ACCESORIOS.....	31

ATELIER LINE | GAMA LABORATORIO

TABLE SAW SIERRA DE MESA	34
SCROLL SAW SIERRA DA MARQUETERIA	35
BELT- DISC SANDER LIJADORA	36
SHARPENING MACHINE AFILADORA	37
BENCH GRINDERS ESMERILADORAS	38-39

CONSTRUCTION RANGE | GAMA DE CONSTRUCTION

CONSTRUCTION TABLE SAW SIERRA DE MESA PARA CONSTRUCTION	40
CHOP SAW TRONZADORA PARA METAL	41
PADDLE MIXERS MESCOLADOR ELECTRICO	42-43
ACCESSORIES ACCESORIOS.....	44-45

METAL WORKING | TRABAJO DE METAL

PORTABLE BAND SAWS SIERRAS DE CINTA PORTATIL	48
BAND SAWS SIERRAS DE CINTA	49-51
DRILL PRESSES TALADROS DE COLUMNA	52-56
METAL LATHE TORNIO PARA METAL	57
ACCESSORIES ACCESORIOS	62-63
STORE MARKETING AND DISPLAYS MARKETING PARA LA TIENDA Y EXPOSITORES	64-65



TR 076



MITRESAWS RANGE GAMA TRONZADORAS DE MADERA

TR 078



TR 230



TR 235



TR 250i

Induction motor
Motor de inducción



New

TR 100



SLIDE COMPOUND MITRESAWS TRONZADORAS DE MADERA TELESCOPICA

TR 077

Belt transmission
Transmission por correa



Ø 210mm



DOUBLE BEVEL

New

TR 1021/DB



LASER

Ø 210mm

TR 250i

Induction motor
Motor de inducción



Ø 250mm

TR 1025/A



LASER

Ø 254mm

TR 305i

Induction motor
Motor de inducción



Ø 305mm



DOUBLE BEVEL

TR 1030DB/A

Belt transmission
Transmission por correa



LIGHT

LASER

Ø 305mm

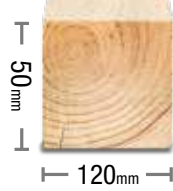

- Solid and stable aluminum upper table
- New handgrip and new upper table adjustment
- Powerful universal motor 1200 W
- Turning table with precision adjustment for oblique cuts angles
- Right sliding piece support
- Left tilting cutting head for oblique cuts

- Mesa superior de aluminio sólido y estable
- Nueva empuñadura y nuevo ajuste altura mesa superior
- Potente motor universal 1200 W Mesa giratoria con ajuste de precisión para cortes oblicuos
- Apoyo de la pieza derecha con deslize
- Cabeza de corte inclinable a la izquierda para cortes oblicuos

STANDARD EQUIPMENT

- Vertical clamp
- Wood pusher / Key set
- Bar stop rod

EQUIPAMIENTO DE SERIE

- Mordaza vertical
- Empuje madera / Llaves en dotación
- Varilla tope regulable

**CUTTING CAPACITY
CAPACIDAD DE CORTE**

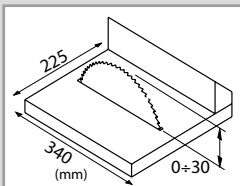
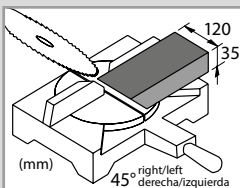
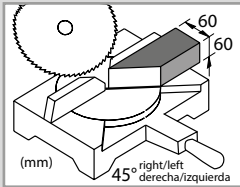
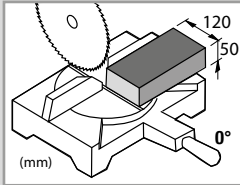

Code Código	EAN CODE
8.42.61.30	8025191804345

Motor power Potencia motor	RPM	Blade diameter Diámetro disco	Article dimensions Artículo dimensiones	Package dimensions Dimensiones del paquete	Weight Peso
			Ax BxC	axb x h	Kg
1200 Watt	4500	D 210 - d30	480x380x290 mm	410x405x345 mm	10

□ Single phase motor 230 Volt - Hz 50 - Motor monofásico 230 - Hz 50

Ø 210mm

ART. **TR 077**

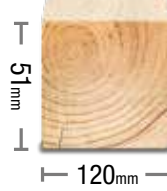

STANDARD EQUIPMENT

- Vertical clamp
- Wood pusher / Key set
- Dust bag

EQUIPAMIENTO DE SERIE

- Mordaza vertical
- Empuje madera / Llaves en dotación
- Bolsa de recogida de polvo

- Ergonomic handle and new design
- Silent motor thanks to belt transmission
- Easy to carry: only 9 Kg
- Turning table with 0°- 22,5°- 30° - 45° angles adjustment
- Right sliding piece support



- Empuñadura ergonómica y diseño novedoso
- Motor silencioso gracias a la transmisión de correa
- Facil de transportar: solamente 9 Kg
- Mesa giratoria con ajuste angulos de 0°- 22,5°- 30° - 45°
- Apoyo de la pieza derecha con deslize

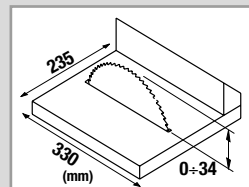
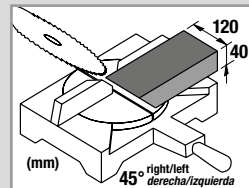
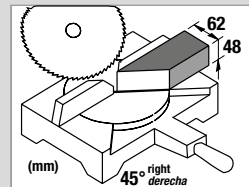
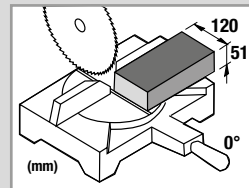

**CUTTING CAPACITY
CAPACIDAD DE CORTE**



Mitresaws • Tronzadoras de madera

Code Código	EAN CODE	Motor power Potencia motor	RPM	Blade diameter Diámetro disco	Article dimensions Artículo dimensiones	Package dimensions Dimensiones del paquete	Weight Peso
					 AxBxC	 axbxh	Kg
8.42.61.33	8025191804581	1200 Watt 	6400	D 210 - d30	290x460x430 mm	470x440x330 mm	8,7

 Single phase motor 230 Volt - Hz 50 - Motor monofásico 230 - Hz 50

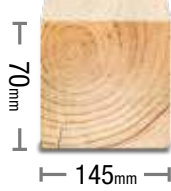

- Compact and light
- Powerful universal motor 1800 W
- Total Aluminum structure
- Turning table with precision adjustment for oblique cuts angles
- Right sliding piece support
- Left tilting cutting head for oblique cuts

- *Compacta y ligera*
- *Potente motor universal 1800 W*
- *Toda la estructura de Aluminio*
- *Mesa giratoria con ajuste de precisión para cortes oblicuos*
- *Apoyo de la pieza derecha con deslize*
- *Cabeza de corte inclinable a la izquierda para cortes oblicuos*

STANDARD EQUIPMENT

- Frontal clamp
- Wood pusher / Key set
- Dust bag

EQUIPAMIENTO DE SERIE

- Mordaza horizontal
- Empuje madera / Llaves en dotación
- Bolsa de recogida de polvo

**CUTTING CAPACITY
CAPACIDAD DE CORTE**

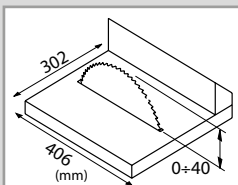
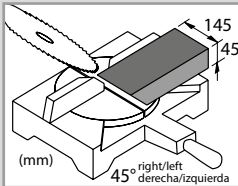
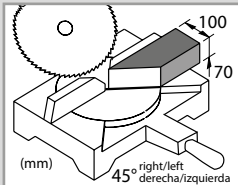
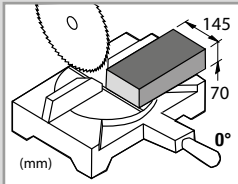

SAFETY GUARD FOR CUTTING ON UPPER TABLE
PROTECCIÓN DE SEGURIDAD PARA CORTE EN LA MESA DE TRABAJO SUPERIOR



Code Código	EAN CODE
8.42.61.38	8025191803478

Motor power Potencia motor	RPM	Blade diameter Diámetro disco	Article dimensions Artículo dimensiones	Package dimensions Dimensiones del paquete	Weight Peso
			AxBxC	axb x h	Kg
1800 Watt	4500	D 250 - d30	570x490x318 mm	500x445x350 mm	15 Kg

Single phase motor 230 Volt - Hz 50 - Motor monofásico 230 - Hz 50

Ø 250mm

ART. **TR 235**

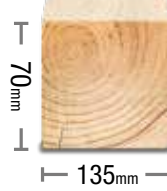

STANDARD EQUIPMENT

- Frontal clamp
- Wood pusher / Key set
- Dust bag
- Side extensions

EQUIPAMIENTO DE SERIE

- Mordaza horizontal
- Empuje madera / Llaves en dotación
- Bolsa de recogida de polvo
- Extensiones laterales

- Upper table height adjustment with double guide
- Solid and sturdy rear joint group
- Big size upper table 426x332 mm
- Turning table with 0°- 22,5°- 30° - 45° angles adjustment
- Tilting head for oblique cuts

- Dispositivo de ajuste altura de la mesa con doble guía
- Articulación trasera sólida y robusta
- Mesa de trabajo superior de gran tamaño 426x332 mm
- Mesa giratoria con ajuste angulos de 0°- 22,5°- 30° - 45°
- Cabeza inclinable para cortes oblicuos



SAFETY GUARD FOR CUTTING ON UPPER TABLE
PROTECCIÓN DE SEGURIDAD PARA CORTE EN LA MESA DE TRABAJO SUPERIOR



**CUTTING CAPACITY
CAPACIDAD DE CORTE**

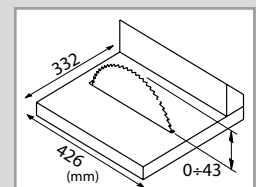
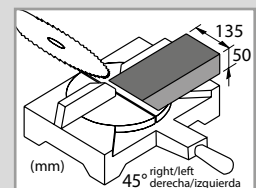
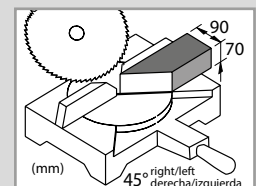
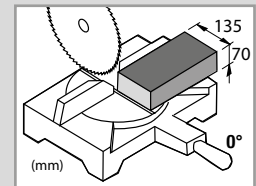

Mitresaws • Tronzadoras de madera

Code Código	EAN CODE
8.42.61.39	8025191803720

Motor power Potencia motor	RPM	Blade diameter Diámetro disco	Article dimensions Artículo dimensiones	Package dimensions Dimensiones del paquete	Weight Peso
			Ax BxC	ax b x h	Kg
1800 Watt	4200	D 250 - d30	580x490x318 mm	420x400x300 mm	16 Kg

Single phase motor 230 Volt - Hz 50 - Motor monofásico 230 - Hz 50

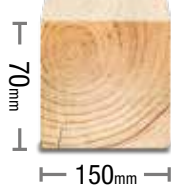

- Powerful universal motor 1600 W
- Aluminium upper work table
- Safety switch
- Easy to carry: only 13,2 Kg
- Turning table with 22,5° - 30° - 45° angles adjustment
- Sliding piece supports
- Upper table straightedge with rapid fixing system

- Potente motor universal 1600 W
- Mesa de trabajo superior de aluminio
- Interruptor de seguridad
- Sólo 13,2 Kg de peso para la máxima portabilidad
- Mesa giratoria con ajuste angulos de 22,5° - 30° - 45°
- Bases de apoyo laterales deslizantes
- Regla superior con bloqueo rápido

STANDARD EQUIPMENT

- Dust bag
- Vertical clamp
- Side extensions
- **EQUIPAMIENTO DE SERIE**
- Bolsa de recogida de polvo
- Mordaza vertical
- Extensiones laterales

**CUTTING CAPACITY
CAPACIDAD DE CORTE**

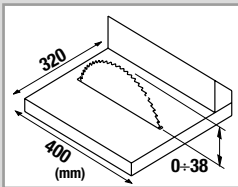
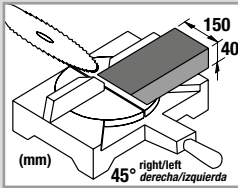
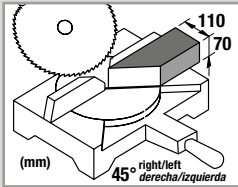
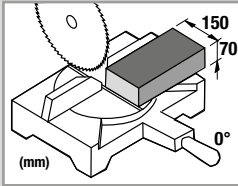

Code Código	EAN CODE
8.42.61.37	8025191806271

Motor power Potencia motor	RPM	Blade diameter Diámetro disco	Article dimensions Artículo dimensiones	Package dimensions Dimensiones del paquete	Weight Peso
			AxBxC	axbxh	Kg
1600 Watt	4800	255x30	700x470x580 mm	530x580x400 mm	16

Single phase motor 230 Volt - Hz 50 - Motor monofásico 230 - Hz 50

**Cut, create,
innovate with job
line mitersaws!
The power that
transforms
wood!**



***!Corta, crea
innova con la
ingletadoras
job line!
!La potencia
que transforma
la madera!***

femi[®]
job Line

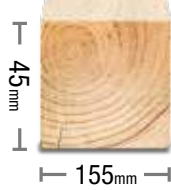

ART.
TR 250i



- Silent induction motor
- Handle with ergonomic design
- Aluminum upper work table
- Turning table with precision adjustment for oblique cuts angles
- Tilting head for oblique cuts

- *Motor de inducción silencioso*
- *Empuñadura de diseño ergonómico*
- *Mesa de trabajo superior de Aluminio*
- *Cabeza inclinable para cortes oblicuos*
- *Mesa giratoria con ajuste de precisión para cortes oblicuos*

STANDARD EQUIPMENT

- Vertical clamp
- Wood pusher / Key set
- Dust bag
- Bar stop rod

EQUIPAMIENTO DE SERIE

- *Mordaza vertical*
- *Empuje madera / Llaves en dotación*
- *Bolsa de recogida de polvo*
- *Varilla tope regulable*

**CUTTING CAPACITY
CAPACIDAD DE CORTE**

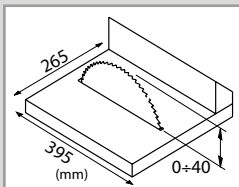
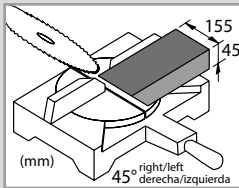
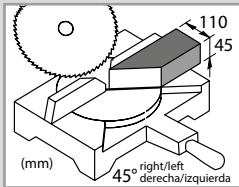
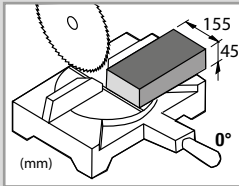

Code Código	EAN CODE
8.42.61.31	8025191804352

Motor power Potencia motor	RPM	Blade diameter Diámetro disco	Article dimensions Artículo dimensiones	Package dimensions Dimensiones del paquete	Weight Peso
			AxBxC	axbxh	Kg
1200 Watt	2850	D 250 - d30a	400x610x490 mm	620x500x410 mm	20

Single phase motor 230 Volt - Hz 50 - Motor monofásico 230 - Hz 50

Ø 250mm

ART. **TR 250i DOUBLE CUT**

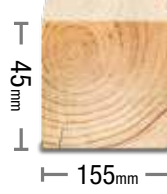

STANDARD EQUIPMENT

- Vertical clamp
- Wood pusher / Key set
- Dust bag
- Bar stop rod

EQUIPAMIENTO DE SERIE

- Mordaza vertical
- Empuje madera / Llaves en dotación
- Bolsa de recogida de polvo
- Varilla tope regulable

- Silent induction motor
- Handle with ergonomic design
- Aluminum upper work table
- Turning table with precision adjustment for oblique cuts angles
- Tilting head for oblique cuts

- Motor de inducción silencioso
- Empuñadura de diseño ergonómico
- Mesa de trabajo superior de Aluminio
- Cabeza inclinable para cortes oblicuos
- Mesa giratoria con ajuste de precisión para cortes oblicuos

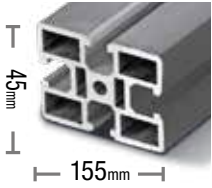

DOUBLE CUT



**CUTTING CAPACITY
CAPACIDAD DE CORTE**

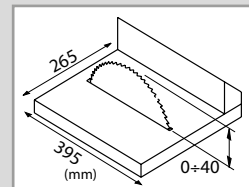
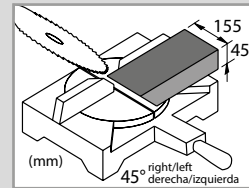
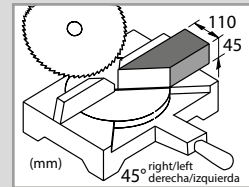
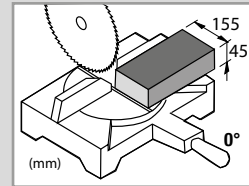





Vertical clamp included
Mordaza vertical incluida



Special blade for aluminium and wood cutting
Disco especial para madera y corte de aluminio

Code Código	EAN CODE
8.42.61.36	8025191805267

Motor power Potencia motor	RPM	Blade diameter Diámetro disco	Article dimensions Artículo dimensiones	Package dimensions Dimensiones del paquete	Weight Peso
			 AxBxC	 axbxh	Kg
1200 Watt 	2850	D 250 - d30a	400x610x490 mm	620x500x410 mm	20

 Single phase motor 230 Volt - Hz 50 - Motor monofásico 230 - Hz 50

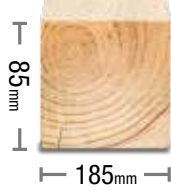

- Powerful universal motor 2000 W
- Upper table height adjustment with double guide
- Solid and sturdy rear joint group
- Big size upper work table 466x381 mm
- Turning table with precision adjustment for oblique cuts angles
- Tilting head for oblique cuts
- Entirely die-cast aluminium structure

- Potente motor universal 2000 W
- Dispositivo de ajuste altura de la mesa con doble guía
- Articulación trasera sólida y robusta
- Mesa de trabajo superior de gran tamaño 466x381 mm
- Mesa giratoria con ajuste de precisión para cortes oblicuos
- Cabeza inclinable para cortes oblicuos
- Estructura completamente en aluminio fundido a presión

STANDARD EQUIPMENT

- Side extensions
- Vertical clamp
- Wood pusher / Key set
- Bar stop rod

EQUIPAMIENTO DE SERIE

- Extensiones laterales
- Mordaza vertical
- Empuje madera / Llaves en dotación
- Varilla tope regulable

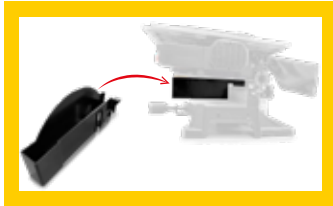

SAFETY GUARD FOR CUTTING ON UPPER TABLE
PROTECCIÓN DE SEGURIDAD PARA CORTE EN LA MESA DE TRABAJO SUPERIOR

UPPER PROTECTION WITH DUST COLLECTOR CONNECTION
PROTECCIÓN SUPERIOR CON CONEXIÓN PARA ASPIRADOR



ERGONOMIC HANDLE WITH SOFT GRIP AND SAFETY START/STOP SWITCH
EMPUÑADURA ERGONÓMICA CON SOFT GRIP Y CON INTERRUPTOR DE SEGURIDAD START/STOP

SELF CENTERING MECHANICAL SPRING LOCK
BLOQUEO AUTOCENTRANTE MECÁNICO DE RESORTE

CUTTING CAPACITY
CAPACIDAD DE CORTE

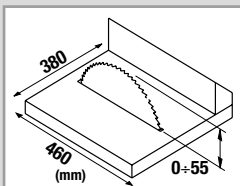
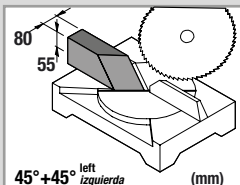
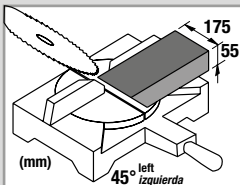
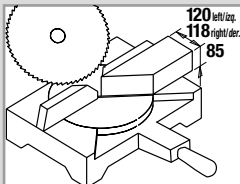
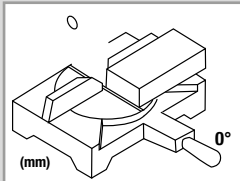

Code Código	EAN CODE
8.43.61.29	8025191806677

Motor power Potencia motor	RPM	Blade diameter Diámetro disco	Article dimensions Artículo dimensiones	Package dimensions Dimensiones del paquete	Weight Peso
2000 Watt	4200	D 305 - d30	AxBxC	axbxh	Kg
			670x520x350 mm	595x570x440 mm	19

Single phase motor 230 Volt - Hz 50 - Motor monofásico 230 - Hz 50

Ø 305mm

ART. **TR 305i**

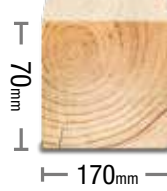

STANDARD EQUIPMENT

- Vertical clamp
- Wood pusher / Key set
- Dust bag
- Bar stop rod

EQUIPAMIENTO DE SERIE

- Mordaza vertical
- Empuje madera / Llaves en dotación
- Bolsa de recogida de polvo
- Varilla tope regulable

- Total aluminium structure
- Silent induction motor
- Ergonomic design handle
- Aluminium upper work table
- Double mitre cut 45°+45°
- Entirely die-cast aluminium structure



- Toda la estructura de aluminio
- Motor de inducción silencioso
- Empuñadura de diseño ergonómico
- Mesa de trabajo superior de Aluminio
- Corte combinado 45°+45°
- Estructura completamente en aluminio fundido a presión

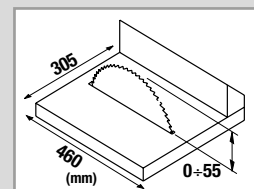
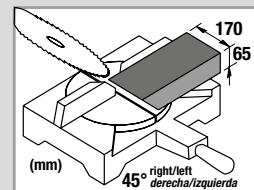
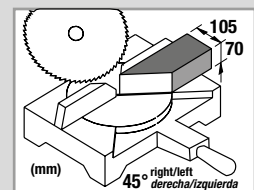
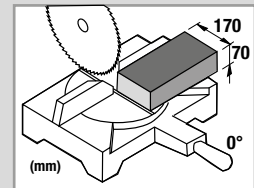

**CUTTING CAPACITY
CAPACIDAD DE CORTE**



Mitresaws · Tronzadoras de madera

Code Código	EAN CODE	Motor power Potencia motor	RPM	Blade diameter Diámetro disco	Article dimensions Artículo dimensiones	Package dimensions Dimensiones del paquete	Weight Peso
					 AxBxC	 axbxh	Kg
8.43.61.30	8025191804369	1400 Watt 	2850	D 305 - d30	465x620x500 mm	630x550x500 mm	25

 Single phase motor 230 Volt - Hz 50 - Motor monofásico 230 - Hz 50

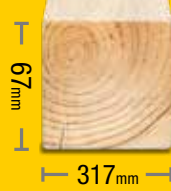

- Easy to carry 10,3 kg net weight
- Anti accidental starting device
- Powerful motor 1700 W
- Low noise with soft start
- Cutting angle with automatic lock at 0°, 15°, 22,5°, 30° And 45°
- Head tilt left and right with mechanical block
- Turning table with precision adjustment for oblique cuts angles
- Left tilting cutting head for oblique cuts

- Sólo 10,3 kg de peso para la máxima portabilidad
- Dispositivo anti arranque accidental
- Potente motor 1700 W
- Bajo ruido con arranque suave
- Ángulo de corte con bloqueo automático a 0°, 15°, 22,5°, 30° y 45°
- Inclinación del cabezal a izquierda y derecha con bloque mecánico
- Mesa giratoria con ajuste de precisión para cortes oblicuos
- Cabeza de corte inclinable a la izquierda para cortes oblicuos

STANDARD EQUIPMENT

- Dust bag / Key set
- Vertical clamp
- Base side extension
- Additional sliding support
- Laser pointer
- Blade Z40

EQUIPAMIENTO DE SERIE

- Bolsa de recogida de polvo
- Mordaza vertical
- Extensiones laterales
- Soportes deslizantes adicionales
- Puntero laser
- Disco Z40

**CUTTING CAPACITY
CAPACIDAD DE CORTE**

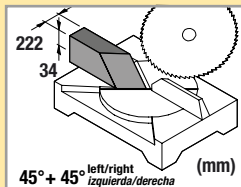
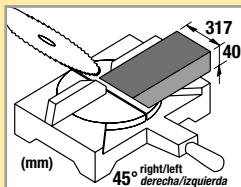
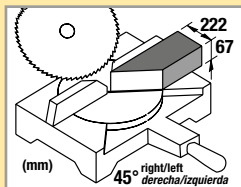
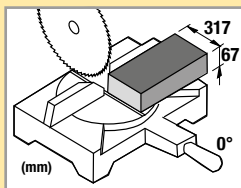

DOUBLE BEVEL



**CARRYING HANDLE
ASA DE TRANSPORTE**



**HANDLES WITH EXTENSION
ASAS CON EXTENSIÓN**

**BASE AND PIECE SUPPORT WITH
INTEGRATED GRADUATED SCALE**

**BASE Y APOYO DE LA PIEZA CON
BÁSCULA GRADUADA INTEGRADA**

Code Código	EAN CODE	Motor power Potencia motor	RPM	Blade diameter Diámetro disco	Article dimensions Artículo dimensiones	Package dimensions Dimensiones del paquete	Weight Peso
							Kg
8.42.45.22	8025191806776	1700 Watt	4700	D 210 - d30	285x830x485 mm	850x500x300 mm	10,3

Single phase motor 230 Volt - Hz 50 - Motor monofásico 230 - Hz 50

Ø 254mm

ART. **TR 1025/A**

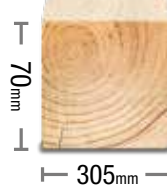

STANDARD EQUIPMENT

- Vertical clamp
- Dust bag collector
- Side extensions
- Kit keys
- Brushes set

EQUIPAMIENTO DE SERIE

- Mordaza vertical
- Bolsa para recoger polvo
- Extensiones laterales
- Llaves incluidas
- Set de carbones de recambio

- Power motor 2200 Watt
- Cutting angle with automatic locking at 15°, 22,5°, 30° and 45°
- Light and portable (19 Kg.)
- Wide cutting capacity 305 mm x 70 mm
- Sliding piece supports with graduated scale
- Laser pointer
- Sturdy alu die cast vertical clamp
- Double sliding cutting bar for greater rigidity

- Potente motor de 2200 Watt
- Angulos de corte con bloqueo automatico a 15°, 22,5° 30° y 45°
- Ligera y transportable (19 kg)
- Grande capacidad de corte 305 mm x 70 mm
- Soporte pieza con medidas graduadas
- Dispositivo laser
- Solida mordaza vertical de aluminio
- Doble barra de deslize de corte para mayor rigidez

**STURDY ALU DIE CAST VERTICAL CLAMP
SOLIDA MORDAZA VERTICAL DE ALUMINIO**

**POWER MOTOR 2200 WATT
POTENTE MOTOR DE 2200 WATT**

**SLIDING PIECE SUPPORTS WITH GRADUATED SCALE
SOPORTE PIEZA CON MEDIDAS GRADUADAS**

**CUTTING ANGLE WITH AUTOMATIC LOCKING
ANGULOS DE CORTE CON BLOQUEO AUTOMATICO**

**CUTTING CAPACITY
CAPACIDAD DE CORTE**

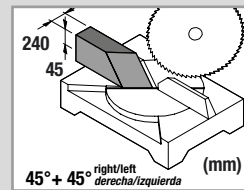
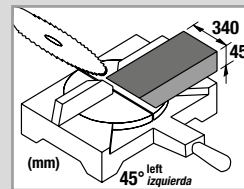
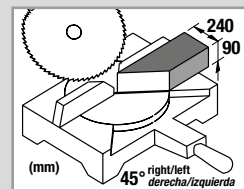
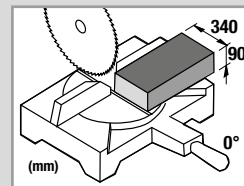

Slide compound mitresaws · Tronzadoras de madera telescópica

Code Código	EAN CODE
8.42.50.30	8025191804826

Motor power Potencia motor	RPM	Blade diameter Diámetro disco	Article dimensions Artículo dimensiones	Package dimensions Dimensiones del paquete	Weight Peso
2200 Watt	5000	D 254 - d30	Ax BxC	axbxh	Kg
			625x685x730 mm	810x560x450 mm	19

Single phase motor 230 Volt - Hz 50 - Motor monofásico 230 - Hz 50

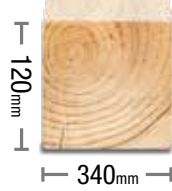

- 2000 W belt drive motor
- Sturdy alu die cast side extension bars with integrated unlock level
- Telescopic cut ideal for very large panels
- Turning table with automatic locking device 0° - 15° - 22,5° - 30° - 45° angles adjustment
- Prearranged cutting angle at 33°
- Double inclination for compound and combined cuts from 0° up to 45° right/left
- Laser and light devices included in the handle
- Right and left support bases with scale indication
- Sturdy alu die cast vertical clamp

- Motor 2000W con transmisión a correa
- Extensiones laterales de aluminio resistentes con palanca de desbloqueo integrada
- Corte radial ideal para paneles muy anchos
- Mesa giratoria con bloqueo automático en los ángulos de precisión 0° - 15° - 22,5° - 30° - 45°
- Predisposición de ángulo de corte de 33°
- Doble inclinación para realizar cortes angulares e inclinados de 0° a 45° derecha / izquierda
- Dispositivos de luz láser y LED incluidos en el mango
- Bases laterales deslizantes con indicación del tamaño de corte
- Resistente mordaza vertical en aluminio para sujetar la pieza

STANDARD EQUIPMENT

- Vertical and frontal clamp
- Key set / Dust bag
- Carbon brushes spare set

EQUIPAMIENTO DE SERIE

- Mordaza vertical y horizontal
- Bolsa de recogida de polvo / Llaves en dotación
- Kit recambio escobillas

**CUTTING CAPACITY
CAPACIDAD DE CORTE**

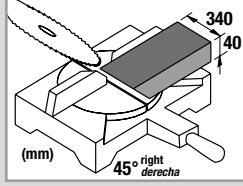
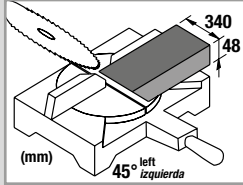
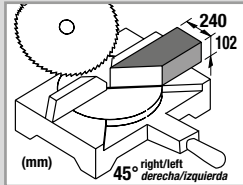
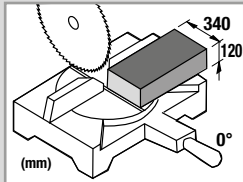

**LARGER CUTTING CAPACITY
MAYOR CAPACIDAD DE CORTE**

**STURDY ALU DIE CAST
VERTICAL CLAMP
SOLIDA MORDAZA
VERTICAL DE ALUMINIO**



**ON HANDLE
EN EL MANGO**



**CUTTING ANGLE
WITH AUTOMATIC
LOCKING DEVICE AND
GRADUATED SCALE**

**SOPORTE PIEZA
CON MEDIDAS
GRADUADAS**



DOUBLE BEVEL

Code Código	EAN CODE
8.43.50.33	8025191806653

Motor power Potencia motor	RPM	Blade diameter Diámetro disco	Article dimensions Artículo dimensiones	Package dimensions Dimensiones del paquete	Weight Peso
2000 Watt	4500	D 305 - d30	 AxBxC	 axbxc	Kg
			655x925x730 mm	860x575x500mm	23

Single phase motor 230 Volt - Hz 50 - Motor monofásico 230 - Hz 50

Code Código				Uses Usos	For ART. Para ART.	EAN CODE
F36-080	210	40	2,5	shredding and ripping of soft/hard/solid woods and plastic materials <i>troceado y corte a lo largo de la veta de: maderas blandas, duras, macizas y materiales plasticos</i>	TR076* TR077* TR1021* TR1021 DB*	8025191302339
F36-082*	250	40	2,8		TR078* TR235* TR250i**	8025191302346
F35-061**	250	60	2,8	ripping and cross cutting of soft/hard woods and plastic materials <i>corte de madera aglomerada y masiza, materiales plasticos</i>		8025191302353
TR36-534*	254	40	2,5	shredding and ripping of soft/hard/solid woods and plastic materials <i>troceado y corte a lo largo de la veta de: maderas blandas, duras, macizas y materiales plasticos</i>	TR240 TR245 - TR230 TR1025DB*	8025191302377
TR36-002*	305	60	3,2	ripping and cross cutting of soft/hard woods and plastic materials <i>corte de madera aglomerada y masiza, materiales plasticos</i>	TR090** TR305i* TR100* TR1030DB*	8025191803256
TR36-001**	305	48	3,2	shredding and ripping of soft/hard/solid woods and plastic materials <i>troceado y corte a lo largo de la veta de: maderas blandas, duras, macizas y materiales plasticos</i>		8025191803249
3278526	250	24	2,5	shredding and ripping of soft/hard/solid woods and plastic materials <i>troceado y corte a lo largo de la veta de: maderas blandas, duras, macizas y materiales plasticos</i>	TR078 TR235 TR250i	8025191301394
3278593	250	28	2	cutting of wood, aluminium sections, non ferrous metals <i>tronzado de madera, elemento perfilados de aluminio, metales non ferrosos</i>	TR250i double cut	8025191303145
3278528	250	40	2,5	shredding and ripping of soft/hard/solid woods and plastic materials <i>troceado y corte a lo largo de la veta de: maderas blandas, duras, macizas y materiales plasticos</i>		8025191300892
3278507	250	60	3,2	ripping and cross cutting of soft/hard woods and plastic materials <i>corte de madera aglomerada y masiza, materiales plasticos</i>	TR078 TR235 TR250i	8025191300977
3278508	250	80	3,2	ripping and cross cutting of lathes and wooden frames <i>corte de filetes y marcos de madera</i>		8025191300960
3278509	250	80 ALU	3,2	cutting of aluminium sections and extrusions <i>tronzado de elementos perfilados y extrusionados de aluminio</i>		8025191300953
3278539*	254	24	2,5	shredding and ripping of soft/hard/solid woods <i>troceado y corte a lo largo de la veta de: maderas blandas, duras y macizas</i>	TR240* TR245* TR230* TR1025DB	8025191301646
3278540	254	40	2,5			8025191301660
3278541	254	80 ALU	3,2			cutting of: aluminium sections and extrusions, non-ferrous metals <i>tronzado de: elementos perfilados y extrusionados de aluminio y metales no ferrosos</i>
3278531	305	48	2,5	shredding and ripping of soft/hard/solid woods and plastic materials <i>troceado y corte a lo largo de la veta de: maderas blandas, duras, macizas y materiales plasticos</i>		8025191301738
3279951	305	72	3,2	ripping and cross cutting of soft/hard woods and plastic materiales <i>corte de madera aglomerada y masiza, materiales plasticos</i>		8025191300878
3279952	305	96	3,2	ripping and cross cutting of lathes and wooden frames <i>corte de filetes y marcos de madera</i>	TR090 TR305i TR100 TR1030DB	8025191300861
3279953	305	84 ALU	3	cutting of aluminium sections and extrusions <i>tronzado de elementos perfilados y extrusionados de aluminio</i>		8025191300854
3279954	305	96 ALU	3		8025191300847	

VERTICAL BANDSAWS RANGE *GAMA SIERRAS DE CINTA*

VB 28-182



VB 28-186



VB 28-191



VB 28-194



CYCLONE DUST COLLECTORS RANGE *GAMA ASPIRADORES DE CICLÓN*

DC 345
PLUS



DC 350
PLUS



DC 351
PLUS
DC 352
PLUS



VB 28-195



RT 400



TABLE ROUTER FRESADORA DA BANCO

PLANER AND THICKNESSER CEPILLADORAS REGRUESADORAS

PF 250



PF 150



PF 204



PF 204
CYCLONE



COMBINED MACHINE MÁQUINA COMBINADA

DC 354
PLUS

DC 355
PLUS



PF 250/600



CM 60-150



- Extremely compact and silent
- Sturdy welded tubular frame
- Tilting table up to 45°
- Adjustable inclination working table 0° - 45°
- Safe changing blade and without tools
- Rip fence for making straight cuts
- Table dimensions: 300 x 300 mm
- Table tilt angle: from 0° to 45°
- Cutting capacity height until: 80 mm
- Vacuum outlet diameter: 40 mm

- *Extremadamente compacto y silencioso*
- *Estructura tubular soldada para una buena estabilidad*
- *Inclinación de la mesa de trabajo hasta 45°*
- *Mesa de trabajo ajustable 0° - 45°*
- *Cambio del disco en seguridad y sin instrumentos*
- *Guía paralela para realizar cortes rectos*
- *Dimensiones de la mesa: 300 x 300 mm*
- *Oscilación de la mesa: de 0° a 45°*
- *Capacidad de altura de corte: 80 mm*
- *Diametro de la abertura de succión: 40 mm*

STANDARD EQUIPMENT

- Blade
- Rip fence
- Wood pusher
- Keys

EQUIPAMIENTO DE SERIE

- Cinta
- Guía
- Apoyo adicional para madera
- Llaves







Tilting table up to 45°

Inclinación de la mesa de trabajo hasta 45°

Maximum cutting capacity up to 80 mm

Máxima capacidad de corte hasta 80 mm

Code Código	EAN CODE
8.50.20.20	8025191805793

Motor power Potencia motor	 mm	 Mm/min	 max mm	Article dimensions Artículo dimensiones	Package dimensions Dimensiones del paquete	Weight Peso
				AxBxC	axbxh	Kg
250W 	1400x6x0,35-Z6	900	200 mm	680x390x490 mm	720x350x275mm	15,5

 Single phase motor 230 Volt - Hz 50 - Motor monofásico 230 - Hz 50

CUTTING HEIGHT
120mm
CAPACIDAD DE CORTE
120mm

ART.
VB 28-186



STANDARD EQUIPMENT

- Blade
- Rip fence / Goniometer
- Wood pusher / Keys
- Stand

EQUIPAMIENTO DE SERIE

- Cinta
- Guía / Goniómetro
- Apoyo adicional para madera / Llaves
- Base

- Sturdy welded tubular frame
- Aluminium table
- Table dimensions: 290 x 290 mm
- Cutting capacity height until: 120 mm
- Blade capacity: from 6 to 13 mm
- Vacuum outlet diameter: 40 mm

- Estructura tubular soldado para mayor resistencia
- Mesa de trabajo en aluminio
- Dimensiones de la mesa: 290 x 290 mm
- Capacidad de altura de corte: 120 mm
- Ancho: de 3 a 13 mm
- Diámetro de la abertura de succión: 40 mm



Aluminium tilting table up to 45°, goniometer include







Mesa de trabajo en aluminio, inclinable hasta 45°, goniómetro incluido



Base included

Base incluida

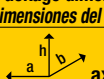
Code Código	EAN CODE
8.50.30.20	8025191805809

Motor power Potencia motor	 mm	 m/min		Article dimensions Artículo dimensiones	Package dimensions Dimensiones del paquete	Weight Peso
				 AxBxC	 a x b x h	Kg
420W 	1790x10x0,35-Z6	660/960	245 mm	1500x650x450 mm	345x880x440mm	30

 Single phase motor 230 Volt - Hz 50 - Motor monofásico 230 - Hz 50

Vertical Bandsaws • Sierras de cinta

- Stand as standard equipment
- Aluminium table of big dimensions
- Sturdy welded tubular frame
- Working table with continuous adjustment (from 0° to 45°)
- Cutting height adjustment without tools
- 2 speeds of use
- Table dimensions: 500 x 400 mm
- Table tilt angle: from 0° to 45°
- Cutting capacity height until: 170 mm
- Blade capacity: from 3 to 15 mm
- Vacuum outlet diameter: 40 mm

- Base incluida
- Estructura tubular soldada para una buena estabilidad
- Mesa de trabajo en aluminio
- Mesa de trabajo con ajuste continuo (de 0° a 45°)
- Ajuste de la altura de corte sin instrumentos
- 2 velocidades de uso
- Dimensiones de la mesa: 500 x 400 mm
- Oscilación de la mesa: de 0° a 45°
- Capacidad de altura de corte: 170 mm
- Ancho: de 3 a 15 mm
- Diámetro de la abertura de succión: 40 mm

STANDARD EQUIPMENT

- Blade
- Rip fence / Goniometer
- Wood pusher / Keys
- Stand

EQUIPAMIENTO DE SERIE

- Cinta
- Guía / Goniómetro
- Apoyo adicional para madera / Liaves
- Base



Tilting table up to 45° goniometer included

Mesa de trabajo inclinable hasta 45°, goniómetro incluido







Maximum cutting height up to 170 mm

Capacidad de corte 170 mm



Code Código	EAN CODE
8.50.40.20	8025191805816

Motor power Potencia motor	 mm	 M/min	 max mm	Article dimensions Artículo dimensiones	Package dimensions Dimensiones del paquete	Weight Peso
				Ax BxC	axb x h	Kg
750W 	2240x12,5x0,5-Z4	360/720	330 mm	1630x800x610 mm	400x1100x500	58

 Single phase motor 230 Volt - Hz 50 - Motor monofásico 230 - Hz 50

CUTTING HEIGHT
224mm
CAPACIDAD DE CORTE
224mm

ART.
VB 28-194



STANDARD EQUIPMENT

- Blade
- Rip fence / Goniometer
- Wood pusher / Keys
- Base

EQUIPAMIENTO DE SERIE

- Cinta
- Guía / Goniómetro
- Apoyo adicional para madera / Llaves
- Base

- Base as standard equipment with practical drawer
- Sturdy welded tubular frame
- Iron workbench of big dimensions
- Table dimensions: 545 x 515 mm
- Table tilt angle: from 0° to 45°
- Cutting capacity height until: 224 mm
- Blade capacity: from 3 to 25 mm
- Vacuum outlets diameter: 47/73/98 mm

- Base incluida con un práctico porta-herramientas
- Estructura tubular soldada para una buena estabilidad
- Mesa de trabajo en hierro fundido de grandes dimensiones
- Dimensiones de la mesa: 545 x 515 mm
- Oscilación de la mesa: de 0° a 45°
- Capacidad de altura de corte: 224 mm
- Ancho: de 3 a 25 mm
- Diámetro de la abertura de succión: 47/73/98 mm









Maximum cutting height up to 224 mm
Máxima capacidad de corte hasta 224 mm



354mm flywheels and blade tensioning device
Volantes de diámetro 354 mm y indicador de tensión de la cinta

Code Código	EAN CODE
8.50.50.20	8025191805823

Motor power Potencia motor	 mm	 m/min	 max mm	Article dimensions Artículo dimensiones	Package dimensions Dimensiones del paquete	Weight Peso
				 AxBxC	 axbxh	Kg
1100W 	2560x10x0,5-Z4	370/800	345 mm	1715x870x750 mm	1260x420x560	75

 Single phase motor 230 Volt - Hz 50 - Motor monofásico 230 - Hz 50

- Reinforced welded steel structure.
- Cast iron wide size table (mm 630x480) with adjusting scale from -10° up to +45° for bevel cuts.
- Silent and powerful induction motor.
- Side wheel access doors fitted with safety micro switch to avoid unsafety restart after a blade changing.
- Height adjustable upper guide with rack.
- 2 heavy cast iron wheels (D.470 mm) perfectly balanced and with a great inertial motion.
- Fence with reading magnifying glass and support guide for edge cuts.
- Table dimensions: 630 x480 mm
- Table inclination: from -10° to 45°
- Gooseneck: 467mm
- Max cutting width: 465mm
- Max cutting height: 280mm
- Blade width: from 6 to 37 mm
- Blade length: 3607 mm
- Blade cutting speed: 420-840 m/min
- Air inlet diameter: 100mm

STANDARD EQUIPMENT

- Blade
- Fence
- Goniometer

EQUIPAMIENTO DE SERIE

- Cinta
- Guía paralela
- Goniómetro.

- Estructura de acero prensado reforzado.
- Mesa de trabajo en hierro fundido de grandes dimensiones (mm 630x480) con ajuste de la escala de -10° hasta +45° para cortes inclinados.
- Motor de inducción potente y silencioso.
- Puertas de acceso a los poleas equipados con un micro interruptor de seguridad para evitar el arranque accidental durante el cambio de la cinta.
- Guía cinta superior ajustable por medio de una cremallera.
- Dos poleas de hierro fundido perfectamente equilibradas con alto movimiento inercial.
- Guía paralela con caja de lectura y guía de apoyo para recortar piezas.
- Dimensiones de la mesa: 630 x480 mm
- Oscilación de la mesa: de -10° a 45°
- Cuello de cisne: 467mm
- Ancho máximo de corte: 465mm
- Altura máxima de corte: 280mm
- Ancho de la cinta: de 6 a 37 mm
- Desarrollo de la cinta: 3607 mm
- Velocidad de corte: 420-840 m/min
- Diámetro de descarga de aire: 100mm



Cutting height 280mm
Altura de corte 280 mm



Screen for blade centering.
Visor para centrar la cinta.



Blade guide with large contact surface of support roller for the great precision of guide.
Guía-hoja con rodillos con grandes superficies de contacto para una alta precisión de corte.



Double bearing for large wood piece.
Rodamientos dobles para tablas de madera anchas.

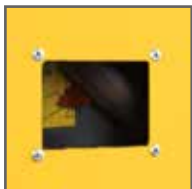

Blade tension reading vernier.
Vernier para leer y registrar la tensión de la cinta.

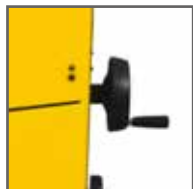

2 cutting speeds.
Dos velocidades de corte.



Quick blade tension release lever.
Palanca para el rápido tensado de la cinta.

ART.	EAN CODE
VB 28-195 700	8025191701286

Kit movimentazione (su richiesta)
Kit de déplacement (sur demande)



Code Código	EAN CODE
8.50.60.20	8025191805830

Motor power Potencia motor	mm	M/min	max mm	Article dimensions Artículo dimensiones	Package dimensions Dimensiones del paquete	Weight Peso
				AxBxC	axbxh	Kg
2200W	3607	900	465 mm	1860x470x750 mm	820x540x2080	162

Single phase motor 230 Volt - Hz 50 - Motor monofásico 230 - Hz 50

ART.
PF 150



STANDARD EQUIPMENT

- No. 2 spare drive belts
- No. 2 blades (already installed)
- Dust chute
- Wood pusher stick
- Aluminium parallele guide for upper table works
- Adjustable parallele fence from 90° to 135° for planing

EQUIPAMIENTO DE SERIE

- 2 correas de transmisión de recambio.
- 2 cuchillas (ya instaladas)
- Boquilla virutas
- Varilla de empuje
- Guía paralela para trabajos sobre la mesa superior de aluminio

- Automatic material feeding (in thickness working)
- Die cast aluminium upper table
- Planing and thicknessing cutting depth micro adjustment
- Anti-rest safety function and safety thermal protection
- Avance automático de la mesa (en el trabajo de espesor)
- Mesa de apoyo superior en aluminio
- Regulación micrométrica de los espesores de cepillado de superficie y espesor
- Sistema de seguridad anti-arranque y protección térmica de seguridad



PLANER | CEPILLADO DE SUPERFICIE

Max planing width mm Anchura max cepillado mm	Cutting adjustment mm Regulación de corte mm	Upper table dimensions mm Dimensiones mesa superior mm	Fence dimensions mm Dimensiones guía paralela mm
158	0 ÷ 2 mm	655x160	480x80

THICKNESSER | CEPILLADO DE ESPESOR

Cutting width mm Anchura max cepillado mm	Cutting thickness mm Altura max cepillado mm	Cutting adjustment mm Regulación de corte mm	Feeding speed mm Velocidad de avance mm
152	120	0 ÷ 2 mm	8 Mt./min

Code Código	EAN CODE
8.44.61.21	8025191802389

Motor power Potencia motor	RPM	Blades Cuchillas	Article dimensions Artículo dimensiones	Package dimensions Dimensiones del paquete	Weight Peso
			AxBxC	axbxh	
1250 Watt [E]	8000	158x20 mm	465x700x400 mm	750x400x450 mm	23

[E] Single phase motor 230 Volt - Hz 50 - Motor monofásico 230 - Hz 50

Planer and thicknessers • Cepilladoras Regruessadoras

ART.
PF 204



STANDARD EQUIPMENT

- No. 2 spare drive belts
- No. 2 blades (already installed)
- Dust chute
- Wood pusher stick
- Aluminium parallele guide for upper table works
- Adjustable parallele fence from 90° to 135° for planing

EQUIPAMIENTO DE SERIE

- 2 correas de transmisión de recambio.
- 2 cuchillas (ya instaladas)
- Boquilla virutas
- Varilla de empuje
- Guía paralela para trabajos sobre la mesa superior de aluminio

- Automatic material feeding (in thickness working)
- Die cast aluminium upper table
- Planing and thicknessing cutting depth micro adjustment
- Anti-rest safety function and safety thermal protection
- Avance automático de la mesa (en el trabajo de espesor)
- Mesa de apoyo superior en aluminio
- Regulación micrométrica de los espesores de cepillado de superficie y espesor
- Sistema de seguridad anti-arranque y protección térmica de seguridad



PLANER | CEPILLADO DE SUPERFICIE

Max planing width mm Anchura max cepillado mm	Cutting adjustment mm Regulación de corte mm	Upper table dimensions mm Dimensiones mesa superior mm	Fence dimensions mm Dimensiones guía paralela mm
210	0 ÷ 2 mm	744x210	500x90

THICKNESSER | CEPILLADO DE ESPESOR

Cutting width mm Anchura max cepillado mm	Cutting thickness mm Altura max cepillado mm	Cutting adjustment mm Regulación de corte mm	Feeding speed mm Velocidad de avance mm
204	120	0 ÷ 2 mm	8 Mt./min

Code Código	EAN CODE
8.44.61.20	802191802310

Motor power Potencia motor	RPM	Blades Cuchillas	Article dimensions Artículo dimensiones	Package dimensions Dimensiones del paquete	Weight Peso
			AxBxC	axbxh	
1250 Watt [E]	8000	210x20 mm	465x785x460 mm	820x460x440 mm	25

[E] Single phase motor 230 Volt - Hz 50 - Motor monofásico 230 - Hz 50

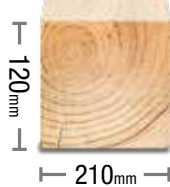

ART.

PF 204 CYCLONE

- Automatic material feeding (in thickness working)
- Die cast aluminium upper table
- Planing and thickening cutting depth micro adjustment
- Anti-rest safety function and safety thermal protection

- *Avance automático de la mesa (en el trabajo de espesor)*
- *Mesa de apoyo superior en aluminio*
- *Regulación micrométrica de los espesores de cepillado de superficie y espesor*
- *Sistema de seguridad anti-arranque y protección térmica de seguridad*

STANDARD EQUIPMENT

- Spare belt kit
- Wood pusher
- Dust chute
- Nr. 2 Blades
- Dust collection bag

EQUIPAMIENTO DE SERIE

- Kit recambio correas
- Empuje madera
- Boquilla virutas
- Nr. 2 Cuchillas
- Bolsa de recogida de virutas

PLANER | CEPILLADO DE SUPERFICIE

Max planing width mm <i>Anchura max cepillado mm</i>	Cutting adjustment mm <i>Regulación de corte mm</i>	Upper table dimensions mm <i>Dimensiones mesa superior mm</i>	Fence dimensions mm <i>Dimensiones guía paralela mm</i>
210	0 ÷ 2 mm	744x210	500x90

THICKNESSER | CEPILLADO DE ESPESOR

Cutting width mm <i>Anchura max cepillado mm</i>	Cutting thickness mm <i>Altura max cepillado mm</i>	Cutting adjustment mm <i>Regulación de corte mm</i>	Feeding speed mm <i>Velocidad de avance mm</i>
204	120	0 ÷ 2 mm	8 Mt./min



Integrated dust suction, circulation and collection system
Sistema integrado de aspiración, circulación y recogida de polvo

Code Código	EAN CODE
8.44.61.22	8025191802860

Motor power Potencia motor	RPM	Blades Cuchillas	Article dimensions Artículo dimensiones	Package dimensions Dimensiones del paquete	Weight Peso
			AxBxC	axbxh	Kg
1500	8000	210x20 mm	465x785x480 mm	820x460x440	28

Single phase motor 230 Volt - Hz 50 - Motor monofásico 230 - Hz 50

ART.
PF 250

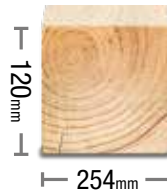

STANDARD EQUIPMENT

- Two blades
- Base
- Dust conveyor
- Rip fence

EQUIPAMIENTO DE SERIE

- Dos cuchillas
- Base
- Dispositivo de aspiración polvo
- Guía

- Table to be planed automatic feed: 6 mt/min
- Safety function dust conveyor
- Table dimensions: 920x262 mm
- Planing width: 254 mm
- Range of cutting depth: from 5 up to 120 mm
- Cutting depth: up to 2 mm
- Feeding speed: 6 mt/min
- Blade dimensions: 261x16,5x1,5 mm

- Alimentación de las piezas de trabajo automático
- Dispositivo de aspiración de polvo con función de seguridad
- Dimensiones de la mesa: 920x262 mm
- Anchura de cepillado: 254 mm
- Regrueso del cepillado: de 5 hasta 120 mm
- Profundidad por pasada: hasta 2 mm
- Velocidad de alimentación: 6 mt/min
- Dimensiones cuchillas: 261x16,5x1,5 mm



Wide work table (920x262 mm) and 45° inclinable rip fence (635x124 mm)

Mesa de trabajo de gran tamaño (920x262 mm) y guía inclinable hasta 45° (635x124 mm)

Code Código	EAN CODE
8.44.61.23	802191805977

Motor power Potencia motor	RPM	Blades Cuchillas	Article dimensions Artículo dimensiones	Package dimensions Dimensiones del paquete	Weight Peso
			AxBxC	axbxh	Kg
1500 Watt	9000	210x20 mm	1100x924x468 mm	1027x508x433 mm	33,5

Single phase motor 230 Volt - Hz 50 - Motor monofásico 230 - Hz 50

Planer and thicknessers · Cepilladoras Regruesadoras

- Cast/iron working table
- Knife holder tool of large diameter to accommodate 3 knives
- Motor with a pulley transmission system keeping the motor efficiency during machining
- Shaft diameter: 75 mm
- Table size: 255 x 1108 mm
- Max cutting depth per pass: 3 mm (thicknesser)
- Max cutting width: 250 mm
- Table size of thicknesser: 250 x 600 mm
- Max cutting depth per pass: 2,5 mm (planer)
- Thicknesser cutting capacity height: 190 mm
- Feed roller diameter: 32 mm
- Feed rate: 8 m/min

- Mesa de trabajo en hierro fundido
- Herramienta de corte de gran diámetro para colocar de 3 cuchillas
- Motor con un sistema de transmisión de la polea que mantiene la eficiencia del motor durante el mecanizado
- Diámetro del eje: 75 mm
- Mesa: 255 x 1108 mm
- Max profundidad de pasada: 3 mm (cepillado de espesor)
- Anchura max cepillado: 250 mm
- Dimensiones de la mesa de trabajo: 250 x 600 mm
- Max profundidad de pasada: 2,5 mm (cepillado de superficie)
- Regrueso altura capacidad de corte: 190 mm
- Diámetro de rodillo de avance: 32 mm
- Velocidad de avance: 8 m/min

STANDARD EQUIPMENT

- Dust conveyor
- 3 blades
- Fence / Safety guard

EQUIPAMIENTO DE SERIE

- Boquilla para pavimentos
- 3 cuchillas
- Guía / Protecciones



Aluminium parallel guide for upper table works
Guía paralela de aluminio para los trabajos de mesa superior



Planner and thicknesser working table mounted on 3 guides in order to avoid the plan rotation
Mesa de trabajo montada sobre tres guías de soporte para evitar la rotación del plan

Code Código	EAN CODE
8.44.61.24	8025191805984

Motor power Potencia motor	RPM	Blades Cuchillas	Article dimensions Artículo dimensiones	Package dimensions Dimensiones del paquete	Weight Peso
2200W	4000	250x30x3	AxBxC	axbxh	Kg
			465x785x480 mm	1130x490x720 mm	148

Single phase motor 230 Volt - Hz 50 - Motor monofásico 230 - Hz 50

STANDARD EQUIPMENT

- Safety guards / Rip fence
- Mortising drill adapters (6-8-10 mm)
- Spindle moulder shaft adapters (6-8 mm)
- Base
- Morticer clamp

EQUIPAMIENTO DE SERIE

- Protecciones / Guía
- Adaptadores puntas fresadora (6-8-10 mm)
- Adaptadores husillo tupi (6-8 mm)
- Base
- Mordaza para fresadora

- Circular saw, sliding carriage, spindle moulder, morticer, planer-thicknesser
- Fast and easy machining functions exchange thanks to two function selectors

- Sierra circular, carro deslizante, tupi, fresadora, cepilladora-calibradora
- Intercambio rápidos y fáciles de funciones gracias a dos selectores



Circular saw ϕ 200 mm with 45° inclinable rip fence
Sierra circular ϕ 200 mm con guía inclinable hasta 45°



Planing operation
Operación de cepillado



Spindle moulder
Tupi



Thicknessing operation (l=154 mm - h 100 mm)
Operación de reguesado (l=154 mm - h=100 mm)



Morticer with sliding carriage
Fresadora con carro deslizante



Sliding carriage with goniometer
Carro deslizante con goniómetro



TECHNICAL FEATURES

Planer-thicknesser

- Planing width: 154 mm
- Table dimensions: 160x620 mm
- Planing capacity: 1,5 mm
- Number of knives: 2
- Rotation speed: 6000 RPM
- Planing height: 100 mm
- Max thicknessing capacity: 2 mm

Circular saw

- Blade: 200x30 mm
- Max cutting height: 60 mm
- Rotation speed: 4200 RPM
- Workbench dimensions: 620x360 mm

Sliding carriage

- Stroke: 500 mm
- Carriage dimensions: 120x740 mm

Spindle moulder

- Spindle diameter: 12 mm
- Spindle travel: 42 mm
- Spindle speed: 9000 RPM

Morticer

- Chuck: 13 mm
- Drills adapter: 6-8-10 mm
- Side stroke: 100 mm
- Depth stroke: 60 mm
- Table dimensions: 260x125 mm

CARACTERÍSTICAS TÉCNICAS

Cepilladora-Reguesadora

- Anchura de cepillado: 154 mm
- Dimensiones de la mesa: 60x620 mm
- Capacidad de cepillado: 1,5 mm
- Numero de cichillas: 2
- Velocidad de rotación: 6000 RPM
- Altura de cepillado: 100 mm
- Capacidad de reguesado: 2 mm

Sierra circular

- Disco: 200x30 mm
- Max altura de corte: 60 mm
- Velocidad de rotación: 4200 RPM
- Dimensiones de la mesa de trabajo: 620x360 mm

Escuadradora

- Recorrido: 500 mm
- Dimensiones: 120x740 mm

Tupi

- Diámetro husillo: 12 mm
- Recorrido husillo: 42 mm
- Velocidad de rotación: 9000 RPM

Fresadora

- Husillo: 13 mm
- Adaptadores de las puntas: 6-8-10 mm
- Recorrido lateral: 100 mm
- Recorrido profundidad: 60 mm
- Dimensiones de la mesa: 260x125 mm

Code Código	EAN CODE
8.44.00.26	8025191806028

Motor power Potencia motor	Article dimensions Artículo dimensiones	Package dimensions Dimensiones del paquete	Weight Peso
	AxBxC	axbxh	Kg
1000	1050x800x840 mm	840x630x470 mm	44

Single phase motor 230 Volt - Hz 50 - Motor monofásico 230 - Hz 50

- Presses steel worktable and extensions
- Right and left worktable extensions
- Worktable dimensions without/with extensions: 610/1030x360 mm
- Cutters height adjustment from 0 to 40 mm
- Maximum dimension of the piece 650x160xH65 mm
- Use of 6/8/12 mm shank cutters
- Worktable inserts D.32/47/55 mm
- Adjustable cutters rotation speed
- Guide for longitudinal cuts
- Suitable for dust collector connection

- Mesa de trabajo y extensiones en acero estampado
- Extensiones de la mesa a derecha e izquierda
- Dimensiones mesa de trabajo sin/con extensiones: 610/1030x360 mm
- Regulación de la altura del cortador de 0 hasta 40 mm
- Dimensiones máxima de la pieza 650x160xH65 mm
- Uso de cortadores de vástago de 6/8/12 mm
- Inserciones para mesa de trabajo D.32/47/55 mm
- Velocidad de rotación del cortador ajustable
- Guía para cortes longitudinales
- Predisposición para la conexión de l'aspirador

STANDARD EQUIPEMENT

- Service key set
- Nr. 2 wood pushers
- Worktable extensions
- Nr. 3 cutters chucks
- Goniometer

EQUIPEMENTS DE SÉRIE

- Set llaves de servicio
- Nr. 2 empuje madera
- Extensiones mesa de trabajo
- Nr. 3 husillos para cortadores
- Goniometro



MOTOR THERMIC PROTECTION RESET
REESTABLECIMIENTO DE LA PROTECCIÓN TÉRMICA DEL MOTOR

ROTATION SPEED ADJUSTMENT
AJUSTE DE LA VELOCIDAD DE ROTACIÓN

START/STOP SWITCH WITH ANTI-RESET SAFETY FUNCTION
INTERRUPTOR DE ARRANQUE/PARADA CON FUNCIÓN DE SEGURIDAD ANTI-RESET

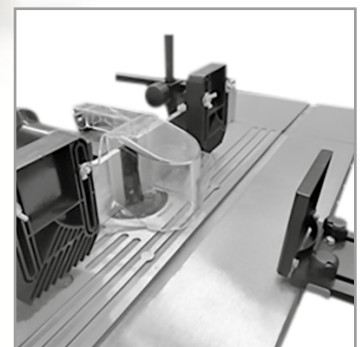

Working height adjustable from 0 to 40 mm
Altura de trabajo regulable de 0 a 40 mm

Code Código	EAN CODE	Motor power Potencia motor	RPM	Shank cutter diameter Diámetro del cortador	Article dimensions Artículo dimensiones	Package dimensions Dimensiones del paquete	Weight Peso
					AxBxC	axbxh	Kg
8.45.10.20	8025191806523	1500 Watt	11.500-24.000	6/8/12 mm	301x400x500 mm 1030 with extensions con extensiones	655x356x255 mm	21

Single phase motor 230 Volt - Hz 50 - Motor monofásico 230 - Hz 50

BANDSAWS | SIERRAS DE CINTA

Code Código	Qty pack Paquete	Description Descripción	For ART. Para ART.	EAN CODE
VB28-183	1	Band saw blade 3 x 1400 x 0,36 mm Z6 Hoja de cinta 3 x 1400 x 0,36 mm Z6	VB28-182	8025191804253
VB28-184*	1	Band saw blade 6 x 1400 x 0,36 mm Z6 Hoja de cinta 6 x 1400 x 0,36 mm Z6		8025191804260
VB28-185	1	Band saw blade 8 x 1400 x 0,36 mm Z6 Hoja de cinta 8 x 1400 x 0,36 mm Z6	F28-182	8025191804277
VB28-166	1	Band saw blade 6 x 1790 x 0,35 mm Z6 Hoja de cinta 6 x 1790 x 0,35 mm Z6	VB28-186	8025191804789
VB28-168*	1	Band saw blade 10 x 1790 x 0,35 mm Z6 Hoja de cinta 10 x 1790 x 0,35 mm Z6		8025191804802
VB28-167	1	Band saw blade 3 x 1790 x 0,65 mm Z10 Hoja de cinta 3 x 1790 x 0,65 mm Z10		8025191804796
F28-169	1	Band saw blade 6 x 1820 x 0,36 mm Z6 Hoja de cinta 6 x 1820 x 0,36 mm Z6	F28-186	8025191804284
F28-170*	1	Band saw blade 10 x 1820 x 0,36 mm Z6 Hoja de cinta 10 x 1820 x 0,36 mm Z6		8025191804291
F28-580	1	Band saw blade 3 x 1820 x 0,65 mm Z10 Hoja de cinta 3 x 1820 x 0,65 mm Z10		8025191803560
VB28-581	1	Band saw blade 3 x 2240 x 0,65 mm Z10 Hoja de cinta 3 x 2240 x 0,65 mm Z10	VB28-191	8025191803577
VB28-577	1	Band saw blade 6,3 x 2240 x 0,5 mm Z6 Hoja de cinta 6,3 x 2240 x 0,5 mm Z6		8025191804307
VB28-578*	1	Band saw blade 12,5 x 2240 x 0,5 mm Z4 Hoja de cinta 12,5 x 2240 x 0,5 mm Z4		8025191804314
VB28-171*	1	Band saw blade 10 x 2560 mm Hoja de cinta 10 x 2560 mm	VB28-194	8025191803218
VB28-172	1	Band saw blade 20 x 2560 mm Hoja de cinta 20 x 2560 mm		8025191803225
VB28-173	1	Band saw blade 25 x 2560 mm Hoja de cinta 25 x 2560 mm		8025191803232
VB28-598	1	Band saw blade 30x3607x 0,6 - Z10 Hoja de cinta 30x3607x 0,6 - Z10	VB28-195	8025191805144
VB28-597*	1	Band saw blade 25x3607x 0,6 - Z3 Hoja de cinta 25x3607x 0,6 - Z3		8025191805137
VB28-596	1	Band saw blade 10x3607x 0,6 - Z6 Hoja de cinta 10x3607x 0,6 - Z6		8025191805120

* Standard fitting | En dotación estándar



PLANER AND THICKNESSER | CEPILLADORA Y REGRUESADORA

Code Código	Qty pack Paquete	Description Descripción	For ART. Para ART.	EAN CODE
PF22-573	2	Knives 261x16,5x1,5 Cuchillas 261x16,5x1,5 	PF 250	8025191302858
PF22-580	3	Knives box 250mm Caja cuchillos 250mm	PF 250/600	8025191302810

DUST COLLECTION BAG | BOLSA DE RECOGIDA DE VIRUTAS

Code Código	For ART. PF204 Cyclone Para ART. PF204 Cyclone	EAN CODE
5.07.32.36		8025191803669

BLADES FOR PLANER AND THICKNESSERS | CUCHILLAS PARA CEPILLADORAS

Code Código	Size Dimensiones	Pack standard Paquete standard	For ART. Para ART.	EAN CODE
3.28.00.10	210 x 20	2 pc. 	PF204 and PF204 Cyclone	8025191301684
3.28.00.14	158 x 20	2 pc. 	PF150	8025191301721

COMBINED MACHINES | MÁQUINAS COMBINADAS

Code Código	Qty pack Paquete	Description Descripción	For ART. Para ART.	EAN CODE
CM60-151	1	Disk blade Ø 200mm z20 Disco Ø 200mm z20	CM 60-150	8025191302681
CM60-152	1	Tools box for combined machines Caja fresas para escopleadora		8025191804697
CM22-579	2	Knives box 154mm Caja cuchillos 154mm		8025191302773
F60-252	1	Disk blade Ø 200mm z18 Disco Ø 200mm z18		8025191302780

- Versatile, handy and powerful, essential for all dust collection operations.
- Powerful, reliable and silent induction motors
- Safety thermal protection
- Suitable for direct connection to wood processing machines.
- Aluminum suction fan (art DC 350PLUS)
- Supplied as assembly kit

- Motores de inducción potentes y fiables.
- Protección térmica de seguridad.
- Adaptación para el acoplamiento con máquinas de carpintería.
- Ventilador de aspiración de aluminio. (Art DC 350PLUS)
- Se suministran en Kit de montaje.

STANDARD FITTINGS

- Base with pivoting wheels
- Flexible pipe 2 mt long
- Floor conveyor (art. DC 350PLUS)
- Nylon bag for wood shavings
- Pressed felt (Filtering capacity 5 µm) dust filter bag
- Pipe diameter reduction kit (art. DC 345PLUS)

EQUIPAMIENTO DE SERIE

- Base con ruedas giratorias
- Tubo flexible longitud 2 m
- Boquilla para pavimentos (art. DC 350PLUS)
- Bolsa de recogida de polvo en nylon
- Bolsa filtrante en hebrado (5 µm) para virutas
- Kit de reducción para diámetro de tubo (art. DC 345PLUS)

DC 350 PLUS



DC 345 PLUS



DC 354 PLUS DC 355 PLUS

DC 351 PLUS DC 352 PLUS



Ø 100/70mm
Ø 70/45mm



Ø 45/40mm
Ø 40/35mm



ART.	Code Código	EAN CODE	Motor power Potencia del motor	M³/h	press. mm H ₂ O	mm	Package dimensions Dimensiones del paquete a x b x h axb x h	Weight Peso
DC 345 PLUS	8.67.42.20	8025191806288	550	1200	71	100x1	895X540X440	18 Kg
DC 350 PLUS	8.67.43.23	8025191806189	900	950	175	100x1	750X460X460	30 Kg
DC 351 PLUS	8.67.44.22	8025191806196	1500	2700	300	100x2	860X820X360	47 Kg
DC 352 PLUS	8.67.44.32	8025191806202	1500	2700	300	100x2	860X820X360	47 Kg
DC 354 PLUS	8.67.47.22	8025191806219	2200	3900	305	100x3	600X850X600	90 Kg
DC 355 PLUS	8.67.47.32	8025191806226	2200	3900	305	100x3	600X850X600	90 Kg

DUST FILTER BAGS | BOLSAS DE RECOGIDA DE POLVO

Code Código	Standard package Paquete estándar	For ART. Para ART.	Liter capacity Capacidad litros	Type of fabric Tipo de tejido	EAN CODE
5.07.32.29	5 pz	DC 350 PLUS	57	Nylon	8025191700791
5.07.32.32	5 pz	DC 351 PLUS - DC 352 PLUS - DC 355 PLUS	170	Nylon	8025191802884
5.07.32.39	5 pz	DC 345 PLUS	60	Nylon	8025191701347

FILTER-BAGS | SACOS FILTRANTES

Code Código	For ART. Para ART.	Size Dimensiones Ø x H mm	Application Aplicaciones	Filtering capacity Capacidad de filtración micron	Type of fabric Tipo de tejido	EAN CODE
5.07.32.28	DC 350 PLUS	370 x 640	Sawdust and wood shaving Polvo y virutas de madera	40	Diagonal cotton Algodón diagonal	8025191700807
5.07.32.33	DC 351 PLUS-DC 352 PLUS-DC 355 PLUS	500 x 870		30	Diagonal cotton Algodón diagonal	8025191802891
5.07.32.34	DC 351 PLUS - DC 352 PLUS - DC 355 PLUS	500 x 870		40	Diagonal cotton Algodón diagonal	8025191100058
5.07.32.30	DC 350 PLUS	370 x 640	Fine dust Polvo fino	30	Pressed felt Hebrado	8025191700784
5.07.32.35	DC 351 PLUS - DC 352 PLUS - DC 355 PLUS	500 x 870		30	Pressed felt Hebrado	8025191100065
5.07.32.37	DC 350 PLUS	370x640		5	Pressed felt Hebrado	8025191701323
5.07.32.38	DC 351 PLUS - DC 352 PLUS - DC 355 PLUS	500 x 870		5	Pressed felt Hebrado	8025191701330
5.07.32.40	DC 345 PLUS	400 x 670		5	Pressed felt Hebrado	8025191701354

MITRESAW-DUST COLLECTOR ADAPTER* ADAPTADOR ASPIRACIÓN TRONZADORAS*

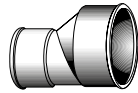

Code Código	Ø reduction Ø reducción	Ø mitresaws coupling Ø acople tronadoras	EAN CODE
5.06.10.44	100 mm	40 mm	8025191700517

* Suitable for all FEMI's mitresaws | Se puede aplicar a todas las tronadoras FEMI

FLOOR CONVEYOR BOQUILLA PARA PAVIMENTOS

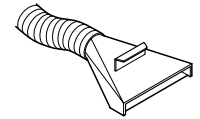

Code Código	For ART. Para ART.	Equipped with suction pipe Tubo de aspiración	EAN CODE
5.18.22.79	DC 350 PLUS	Ø 100 mm	8025191700524

GATE VALVE FOR SUCTION PIPE VÁLVULA DE CIERRE PARA TUBO DE ASPIRACIÓN

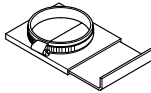

Code Código	For suction pipe ASP. Para tubo ASP.	Equipped with: Provista de:	EAN CODE
5.24.13.29	Ø 100 mm	Pipe clamps Abrazaderas para tubos	8025191700715

SUCTION PIPE TUBO DE ASPIRACIÓN

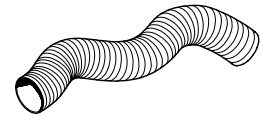

Code Código	Ø mm	Min. order Pedido min	EAN CODE
1.95.99.10	100	3 mt.	8025191100003



GAMA LABORATORIO

SCROLL SAW | SIERRA PARA MARQUETERIA

ss 40-562



TABLE SAW | SIERRA DE MESA

TS 36-523



BELT/DISC SANDER | LJADORA

BD 31-462



SHARPENING MACHINE | AFILADORA

SH 23-730



BENCH GRINDERS | ESMERILADORAS

BG 25N



BG 26N



BG 31N



BG 33N



BG 36N



BG 56N



BG 34N



BG 46N



CONSTRUCTION RANGE



GAMA DE CONSTRUCCION

TABLE SAW | *SIERRA DE MESA*

CHOP SAW | *TRONZADORA PARA METAL*

TS 36-528



cs 20-140



PADDLE MIXERS | *MEZCLADORAS*

EM 78-140



EM 78-180



- Two side extensions made of pressed steel
- Light, compact and easy to carry
- Frontal knob for height adjustment and blade tilting
- 2 in 1 blade adjustment (height and inclination)
- Blade transparent protection with dust suction fitting
- Angular guide for oblique cuts (+/- 60°)
- Maximum cutting height 0°: 80 mm
- Maximum cutting height 45°: 60 mm
- Workbench dimensions: 550x570 mm
- Workbench dimensions with extensions: 990x570 mm

- *Dos extensiones laterales de chapa de acero.*
- *Ligero, compacto y fácil de transportar*
- *Regulación de la altura y de la inclinación del disco por medio de una empuñadura delantera*
- *Ajuste 2 en 1 del disco (altura e inclinación)*
- *Protección transparente del disco con union para aspiración virutas*
- *Guía angular par cortes oblicuos (+/- 60°)*
- *Altura max de corte a 0°: 80 mm*
- *Altura max de corte a 45°: 60 mm*
- *Dimensiones de la mesa: 550x570 mm*
- *Dimensiones de la mesa con extensiones laterales: 990x570 mm*

STANDARD EQUIPMENT

- Base
- Wood pusher
- Dust suction pipe
- Two extensions
- Goniometer
- Rip fence

EQUIPAMIENTO DE SERIE

- Base
- Empuje madera
- Tubo de aspiración de polvo
- Dos extensiones
- Goniómetro
- Guía



Code Código	EAN CODE	Motor power Potencia motor	RPM	Blade diameter Diámetro disco	Article dimensions Artículo dimensiones	Package dimensions Dimensiones del paquete	Weight Peso
8.45.00.25	8025191805953	1800 Watt	5700	254	 AxBxC	 axbxh	Kg
					1000x1000x750 mm	700x570x330	24 Kg

Single phase motor 230 Volt - Hz 50 - Motor monofásico 230 - Hz 50

Ø 250mm

ART.
SS 40-562

femi
job Line®

STANDARD EQUIPMENT

- Blade
- Led lamp
- Blower for workbench cleaning
- Key set / Blade protection
- Clamp
- Flexible shaft
- Tool kit and adapter to assemble blades with and without pin
- Foot pedal

EQUIPAMIENTO DE SERIE

- Hoja
- Lámpara led
- Soplador de limpieza
- Kit de llaves / Protección para la hoja
- Mordaza
- Eje flexible
- Herramientas y adaptador para el montaje de las hojas con y sin pin
- Pedal

- Flexible shaft and tool kit allowing to perform all finishing off work
- Very light aluminium die cast parallel arm to avoid vibrations and performing high precision cutting
- Electronic speed regulation for different materials through pedal control
- Tilting working table for all type of cuts
- Blade speed: 550-1600 cps/min
- Table dimensions: 414x250 mm
- Throat capacity: 405 mm
- Table tilting: from 0° up to 45°
- Height cutting capacity 0°: 50mm - 45°: 20mm
- Blade length: 127 mm

- *Kit de herramientas y eje flexibles que le permiten realizar trabajos de acabado*
- *Brazo paralelo en aluminio fundido muy ligero para evitar vibraciones y para una alta precisión de corte*
- *Regulación electrónica de velocidad para el trabajo de materiales diferentes mediante control de pedal*
- *Mesa de trabajo inclinable para todos los tipos de corte*
- *Velocidad de la hoja: 550-1600 cps/min*
- *Dimensiones de la mesa: 414x250 mm*
- *Capacidad cuello de cisne: 405 mm*
- *Oscilación de la mesa: de 0° hasta 45°*
- *Capacidad de corte en altura: 0°: 50mm - 45°: 20mm*
- *Largo de la hoja: 127 mm*

PROVIDED WITH FLEXIBLE SHAFT AND TOOL KIT

PROVISTA CON EJE FLEXIBLE Y KIT DE HERRAMIENTAS



Quick blade fastening system
Sistema de fijación rápida de la hoja





Tool kit for grinding and brushing machining
Kit de herramienta suministrada para las operaciones de lijadura y cepilladura

Led light
Lámpara led



Foot pedal switch on and off in maximum security
Encendido y apagado en la máxima seguridad

Code Código	EAN CODE
8.49.20.20	8025191806004

Motor power Potencia motor	Article dimensions Artículo dimensiones	Package dimensions Dimensiones del paquete	Weight Peso
	 AxBxC	 axbxh	Kg
125 Watt 	380x320x630 mm	675x395x320 mm	16

 Single phase motor 230 Volt - Hz 50 - *Motor monofásico 230 - Hz 50*

Scroll saw · Sierra para marquetería

- Cast iron frame
- Powerful and silent asynchronous motor
- Tilting belt working table from 0° up to 90°

Sanding belt

- Width: 100 mm
- Length: 914 mm
- Speed: 655 mt/min
- Table length: 360 mm

Sanding disc

- Diameter: 150 mm

Workbench

- Dimensions: 158x225 mm
- Inclination: 45° down

- Marco de hierro fundido
- Motor asincrono potente y silencioso
- Mesa de la banda inclinable de 0° hasta 90°

Banda

- Ancho: 100 mm
- Largo: 914 mm
- Velocidad: 655 mt/min.
- Largo de la mesa: 360 mm

Disco abrasivo

- Diametro: 150 mm

Mesa de trabajo

- Dimensiones: 158x225 mm
- Inclinación: 45° bajo

STANDARD EQUIPMENT

- Sanding belt grain 60
- Self-adhesive disc grain 60
- Goniometer

EQUIPAMIENTO DE SERIE

- Banda grano 60
- Disco autoadhesivo grano 60
- Goniómetro

**BELT/DISC SANDER
BELT 100 MM AND
DISC Ø 150 MM**

**LIJADORA COMBINADA
BANDA 100 mm
Y DISCO Ø 150 mm**



Workbench with goniometer and 150 mm disc for sanding curved workpieces or angular ends.

Mesa de trabajo con goniómetro y 150 mm de disco abrasivo para pulir piezas curvadas o para trabajar los extremos angulares.



Sander in vertical position with workbench and goniometer.

Lijadora en posición vertical con mesa de trabajo y goniómetro.



Code Código	EAN CODE
8.28.62.20	8025191806011

Motor power Potencia motor	RPM	mm x mm	mm	Article dimensions Artículo dimensiones	Package dimensions Dimensiones del paquete	Weight Peso
				AxBxC	axbxh	Kg
370 Watt	2850	100x914	D 150	370x478x292 mm	560x270x315	19,5

Single phase motor 230 Volt - Hz 50 - Motor monofásico 230 - Hz 50

ART.

SH 23-730**femi**
job Line**STANDARD FITTINGS**

- Adjustable support for different tools
- Handle for the transport
- Sharpening wheel
- Leather disc
- Keys and accessories for the maintenance
- Goniometer
- Grinding compound

EQUIPAMIENTO DE SERIE

- Soporte ajustable para herramientas
- Empuñadura para el transporte
- Muela afiladora
- Disco de cuero
- Llaves y accesorios para el mantenimiento
- Goniómetro
- Compuesto para asentado

- Reversing rotation of the wheel through I/O button for accurate sharpening works: no need to move tools support
- Carrying handle for the transport
- Tools support as standard equipment
- Wheels rotation speed: 95 RPM
- Sharpening wheel dimensions: 200x40x12 mm
- Leather disc dimensions: 200x30x12 mm

- Inversión de la rotación de la rueda a través del pulsador I/O para la precisa afiladura sin mover el soporte para herramientas
- Empuñadura para el transporte
- Soporte ajustable para herramientas
- Velocidad de rotación de las ruedas: 95 RPM
- Dimensiones de la muela afiladora: 200x40x12 mm
- Dimensiones del disco de cuero: 200x30x12 mm

Sharpening machine · Afiladora



SH23-010 (on demand / bajo pedido)
Stone grader
Aparadores de muela



SH23-160 (on demand / bajo pedido)
Scissors support
Soporte para tijeras



SH23-210 (on demand / bajo pedido)
Blades and knives support 160-270 mm
Soporte para cuchillos 160-270 mm



SH23-110 (on demand / bajo pedido)
Universal support base
Base soporte universal





SH23-040 (on demand / bajo pedido)
Axes support
Soporte para hacha



SH23-220 (on demand / bajo pedido)
Profiled leather honing disk
Disco de cuero para internos



Code Código	EAN CODE
8.13.22.29	8025191805991

Motor power Potencia motor	RPM	Article dimensions Artículo dimensiones	Package dimensions Dimensiones del paquete	Weight Peso
		 AxBxC	 axbxh	Kg
150 Watt 	1400	398x420x225 mm	385x370x360 mm	10

 Single phase motor 230 Volt - Hz 50 - Motor monofásico 230 - Hz 50

BG 25N

BENCH GRINDER Ø 125mm
ESMERILADORA Ø 125mm



BG 26N

BENCH GRINDER Ø 150mm
ESMERILADORA Ø 150mm



BG 31N

BENCH GRINDER Ø 150mm
ESMERILADORA Ø 150mm



BG 33N

BENCH GRINDER Ø 200mm
ESMERILADORA Ø 200mm



BG 36N

BENCH GRINDER/POLISHER Ø 150mm
ESMERILADORA-PULIDORA Ø 150mm



BG 56N

BENCH GRINDER/LINISHER Ø 150mm
ESMERILADORA - LIJADORA Ø 150mm



BG 34N















COMBINED SHARPENING MACHINE Ø 150mm
AFILADORA COMBINADA Ø 150mm



BG 46N

COMBINED SHARPENING MACHINE Ø 150-200mm
AFILADORA COMBINADA Ø 150-200mm



ART.	Code Código	EAN CODE	Motor power Potencia motor	 Ø mm	 Ø mm	RPM	 Ø mm	 mm x mm	Article dimensions Artículo dimensiones	Package dimensions Dimensiones del paquete	Weight Peso
									 AxBxC	 axbxh	
BG 25N	8.14.00.23	8025191805861	150 	125x16x12,7	-	2950	-	-	230x280x170	295x180x210	5
BG 26N	8.14.01.21	8025191805878	150 	150x16x12,7	-	2950	-	-	230x280x170	310x205x230	6
BG 31N	8.11.02.22	8025191805885	330 	150x20x12,7	-	2950	-	-	295x350x225	390x260x270	9
BG 33N	8.11.04.22	8025191805892	370 	200x20x16	-	2950	-	-	320x370x230	400x290x295	14
BG 36N	8.12.03.24	8025191805915	330 	150x20x12,7	150x20x16	2950	-	-	285x440x230	480x255x255	9
BG 56N	8.17.02.22	8025191805939	330 	150x20x12,7	-	2950	-	50x680	365x360x350	440x400x260	9
BG 34N	8.13.02.30	8025191805908	250 	150x20x12,7	-	2950	150x40x20	-	295x370x230	410x200x255	14
BG 46N	8.13.02.27	8025191805922	330 	150x20x12,7	-	2950/140	200x40x20	-	285x450x230	470x310x305	10

 230 Volt - Hz 50 single-phase motor | Motor monofásico 230 Volt - Hz 50

TECHNICAL FEATURES

- Exclusive design (international FEMI patent)
- Powerful and silent induction motors
- Equipped with complete accident prevention guards

CARACTERÍSTICAS TÉCNICAS

- Diseño exclusivo (patente internacional FEMI)
- Potentes y silenciosos motores de inducción
- Provistas de protecciones completas para prevención de accidentes





STANDARD FITTINGS

- Large supporting base with removable water tank (excluded art. BG 25N/BG 26N)
- Dust conveyor guard (art. BG 36N)
- Equipped with grinding wheels, steel brushes and sand belts

EQUIPAMIENTO DE SERIE

- Base de plástico con recipiente para el agua desmontable (no art. BG 25N/BG 26N)
- Protección visual de seguridad (art. BG 36N)
- Provistas de muelas abrasivas, cepillos de acero y bandas abrasivas

Wheels, brushes and sanding belts | Muelas /cepillos/bandas abrasivas

Code Código	 Ø mm	 Ø mm	 Ø mm	 mm x mm	Grain Grano	Pieces Nr. Piezas n°	For ART. Para ART	EAN CODE
3.22.99.34	125x16x12	-	-	-	36	1	BG 25N	8025191302483
3.22.99.35	125x16x12	-	-	-	60	1		8025191302490
3.22.99.23	150x20x16/12*/12,7*	-	-	-	36*	1	BG 26N•BG 31N•BG 34N* •BG 36N**•BG 46N*•BG 56N*	8025191803874
3.22.99.24	150x20x16/12*/12,7*	-	-	-	60**	1		8025191803881
3.22.99.25	200x20x16	-	-	-	36	1	BG 33N	8025191803898
3.22.99.26	200x20x16	-	-	-	60	1		8025191803904
3.22.13.85	-	150x40x12,7	-	-	80	1	BG 34N	8025191303152
3.22.99.27	-	200x40x20	-	-	80	1	BG 46N	8025191803911
3.23.99.35	-	-	150x20x16	-	-	1	BG 36N	8025191300670
3.23.99.16	-	-	-	50x680	80	5	BG 56N	8025191300458

*With reduction bushing included in the packaging | *Con reducciones incluidas

* standard fitting | * en dotacion estándar • BG 25N - BG 26N - BG 31N - BG 33N: 1 grinding wheel grain 36 | 1 muela grano 36 • 1 grinding wheel grain 60 | 1 muela grano 60

WHEELS, BRUSHES AND SANDING BELTS

Disk grinding wheels either made of gray corundum (carborundum) and ceramics binder (bench grinders) or of high quality white corundum and glazed ceramics binder (sharpening machines).

Corundum sand belts, high resistance reinforced fabric support and ground joints for greater smoothness.

Grinding wheels and belts available in different grits: the higher the number the finer the grit (suitable for deburring and finishing), whereas the lower the number the rougher the grit (suitable for grinding and roughing-out).

MUELAS, CEPILLOS Y BANDAS

Muelas de disco de corindón gris (carburo de silicio) y aglutinante cerámico (esmeriladoras) o bien de corindón fino blanco y aglutinante cerámico vitrificado (afiladoras).

Bandas abrasivas de corindón, soporte de tela reforzada de gran resistencia, Uniones lijadas para garantizar un mayor deslizamiento.

Muelas y bandas disponibles en diferentes granos: a un número más alto corresponde un grano más fino (ideal para desbarbados y acabados), mientras que a un número más bajo corresponde un grano más grueso (ideal para esmerilado y desbastado).



- 2000 Watt powerful induction motor suitable in the building site or in the workshop to cut boards or panels
- Ø 315 mm blade with Widia inserts which can be tilted up to 45°
- Steel sheet workbench with extensions for a smooth wood boards support and sliding
- The base is provided with handles and wheels for an easy transport
- Table extension for long pieces cutting
- Tilting blade up to 45° for oblique cuts
- Workbench dimensions: 800x550 mm
- Base extension: 800x400 mm
- Workbench length before/after the blade: 260/970 mm (with extension)
- Max cutting height 0°: 83 mm
- Max cutting height 45°: 49 mm

- Potente motor de inducción 2000 Watt adecuado para cortar placas y paneles en las obras de construcción o en laboratorios
- Disco Ø 315 mm con inserciones de Widia inclinable hasta 45°
- Mesa de trabajo en chapa de acero con extensiones de la mesa por el apoyo y deslizamiento de las placas
- La base está provista de asas y ruedas para facilitar el movimiento de la máquina
- Estension de la mesa para el corte de las piezas largas
- Disco inclinable hasta los 45° para cortes obliquos
- Dimensiones de la mesa de trabajo: 800x550 mm
- Extension de la base: 800x400 mm
- Longitud de la mesa antes/después el disco: 260/970 mm (con extension)
- Altura max de corte a 0°: 83 mm
- Altura max de corte a 45°: 49 mm

STANDARD EQUIPMENT

- Rip fence
- Handles for transport
- Workbench extension
- Wheels

EQUIPAMIENTO DE SERIE

- Guia
- Asas para el transporte
- Extension de la mesa de trabajo
- Ruedas



Handles for easy transport of the machine
Asas par facilitar el movimiento da la máquina



2000 Watt powerful induction motor assembled under the workbench
Potente motor de inducción 2000 Watt montado debajo de la mesa de trabajo

Code Código	EAN CODE
8.45.00.26	8025191805960

Motor power Potencia motor	RPM	Blade diameter Diámetro disco	Article dimensions Artículo dimensiones	Package dimensions Dimensiones del paquete	Weight Peso
			AxBxC	axbxh	Kg
1200 Watt	2850	315	1200x1200x620 mm	890x610x440mm	15,5

Single phase motor 230 Volt - Hz 50 - Motor monofásico 230 - Hz 50

Ø 355mm

ART. **CS 20-140**

femi
job Line®

STANDARD EQUIPMENT

- Abrasive disc for ferrous metals
- Vice and key

EQUIPAMIENTO DE SERIE

- Disco abrasivo para metales ferrosos
- Mordaza y llave

- 2000 Watt powerful motor for a greater cutting speed
- Transmission with a helical gear mounted on bearing
- Easy to carry thanks to the additional handle
- Cutting capacity at 0° (with vice)
- Circular profile 127 mm
- Rectangular profile 127x152 mm
- Square profile 127x127 mm

- Potente motor 2000 Watt para una mayor velocidad de corte
- Transmisión realizada con un engranaje helicoidal montado sobre rodamientos
- Transporte facil gracias al asa adicional
- Capacidad de corte a 0° (con mordaza)
- Perfil circular 127 mm
- Perfil rectangular 127x152 mm
- Perfil cuadrado 127x127 mm

Chop saw · Tronzadora para meta



**ABRASIVE DISC
DISCO ABRASIVO**



Vertical handle
Empuñadura vertical





Easy transport
Máxima portabilidad

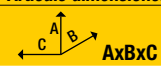
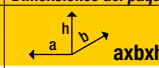

Quick lock vice for clamping workpieces from 0° to 45°
Mordaza de acción rápida para blocaje de piezas de 0° a 45°

Code Código	EAN CODE
8.41.20.22	8025191805786

Motor power Potencia motor	RPM	Blade diameter Diámetro disco	Article dimensions Artículo dimensiones	Package dimensions Dimensiones del paquete	Weight Peso
			 AxBxC	 axbxh	Kg
2000 Watt 	3000	355 mm	480x380x290 mm	600x340x430	18

 Single phase motor 230 Volt - Hz 50 - Motor monofásico 230 - Hz 50

- Suitable to mix paints, glues and finish products. Medium/big volume materials to be mixed.
- Gradual motor start.
- Electronic speed regulation: 150 - 300 mt/min. - 300 - 650 mt/min.
- Speed from 150 to 300 / 300 to 650 rpm
- Paddle H2: Ø 140mm
- Paddle connection: M14

- *Ideal para mezclar pinturas, pegamentos y productos de acabado. Para medios/grandes volúmenes de material a ser mezclado.*
- *Arranque del motor progresivo.*
- *Regulación electrónica de la velocidad: 150 - 300 mt/min. - 300 - 650 mt/min*
- *Velocidad de 150 a 300 / 300 a 650 rpm*
- *Varilla H2: Ø 140mm*
- *Conexión varilla: M14*

STANDARD EQUIPMENT

- 1 paddle H2 - h 600 ø 140mm

EQUIPAMIENTO DE SERIE

- 1 varilla H2 de ø 140 x H. 600mm

**1400 WATT
2 SPEEDS ELECTRONIC
REGULATION**

**1400 WATT
2 VELOCIDADES
CON REGULACIÓN
ELECTRÓNICA**



Sturdy and reliable motor gear transmission. Two mechanical speeds with electronic regulation (even for EM 78-180).

Motor robusto y fiable con transmisión de engranajes. Dos velocidades mecánicas con regulación electrónica (también para EM 78-180).

Art. EM 76-000

Display for EM 78-140
EM78-180 and paddles

*Expositor para EM 78-140
EM 78-180 y varilla*



Code Código	EAN CODE
8.05.20.20	8025191805847

Motor power Potencia motor	Article dimensions Artículo dimensiones	Package dimensions Dimensiones del paquete	Weight Peso
	AxBxC	axbxh	Kg
1400 Watt	920x165x250 mm	630x360x240	7

Single phase motor 230 Volt - Hz 50 - Motor monofásico 230 - Hz 50

ART.
EM 78-180

STANDARD EQUIPMENT

- Supplied in shockproof carboard box and two paddles included:
h 600 ø 140mm. H3 type (EM 77-120) and h 600 ø 160mm. H2 type (EM 77-030)

EQUIPAMIENTO DE SERIE

- Incluido en la caja de carton con dos varillas incluidas:
h 600 ø 140mm. Varilla H3 (EM 77-120) e h 600 ø 160mm. Varilla H2 (EM 77-030)

- The product has been conceived for professional use and for mixing even big volumes of high viscosity materials.
- 1800 powerful motor for a great mixing strength.
- Speed : from 150 to 300 / 300 to 650 rpm
- Paddle H2: ø 160mm
- Paddle H3: ø 140mm
- Paddle connection: M14

- Diseñado para uso profesional, para mezclar materiales de alta viscosidad, tambien en grandes volúmenes.
- 1800 motor robusto y con gran fuerza de mezcla
- Velocidad: de 150 a 300 / 300 a 650 rpm
- Varilla H2: ø 160mm
- Varilla H3: ø 140mm
- Conexión varilla: M14

**1800 WATT
2 SPEEDS ELECTRONIC
REGULATION**

**1800 WATT
2 VELOCIDADES
CON REGULACIÓN
ELECTRÓNICA**





**2 paddles
included
2 varillas
de serie**

Shockproof box for transport (included)
Caja para el transporte (incluida)



Electronic speed control.
Control electrónico de velocidad.

Code Código	EAN CODE
8.05.20.21	8025191805854

Motor power Potencia motor	Article dimensions Artículo dimensiones	Package dimensions Dimensiones del paquete	Weight Peso
	 AxBxC	 axbxh	Kg
1800 Watt 	920x165x250 mm	620x360x240	9

 Single phase motor 230 Volt - Hz 50 - Motor monofásico 230 - Hz 50

BELT/DISC SANDER | LIADORA

Code Código	Qty pack Paquete	Description Descripción	For ART. Para ART.	EAN CODE
BD31-464	5	Abrasive belt 100x914mm grain150 <i>Lija abrasiva 100x914mm – 150 grano</i>	BD31-462	8025191302537
BD31-465	5	Abrasive belt 100x914mm grain 60 <i>Lija abrasiva 100x914mm – 60 grano</i>		8025191302544
BD31-466	5	Abrasive belt 100x914mm grain 100 <i>Lija abrasiva 100x914mm – 100 grano</i>		8025191302551
BD31-467	5	Abrasive disk 150mm grain 60 <i>Disco abrasivo 150 mm – 60 grano</i>		8025191302568
BD31-468	5	Abrasive disk 150mm grain 100 <i>Disco abrasivo 150 mm – 100 grano</i>		8025191302575
BD31-469	5	Abrasive disk 150mm grain 150 <i>Disco abrasivo 150 mm – 150 grano</i>		8025191302582



SHARPENING MACHINE | AFILADORA

Code Código	Qty pack Paquete	Description Descripción	For ART. Para ART.	EAN CODE
SH23-010	1	Stone grader <i>Piedra para rectificar las muelas</i>	SH23-730	8025191302254
SH23-210	1	Blade and knives support 160-270 mm blade minimum thickness 14 mm <i>Soporte para sierra y cuchillos 160-270 mm espesor mínimo de cuchillo 14mm</i>		8025191302315
SH23-200	1	Leather disk 200x30x12,5 mm (only for art F23-730 Plus) <i>Disco de cuero 200x30x12,5 mm (para art. F23-730 Plus solo)</i>		8025191302308
SH23-220	1	Profiled leather honing disk (only for art F23-730 Plus) <i>Disco de cuero perfilado (para art. F23-730 Plus solo)</i>		8025191302322
SH23-160	1	Scissors support <i>Soporte para tijeras</i>		8025191701156
SH23-040	1	Axes support <i>Soporte para hacha</i>		8025191701163
SH23-110	1	Universal support base <i>Soporte universal</i>		8025191701170
SH23-020	1	Spare grinding wheel 200x40x12 – grana 220 <i>Muela de repuesto 200x40x12 – grano 220</i>		8025191302261
SH23-080	1	Grinding compound <i>Pasta abrasiva</i>		8025191302285

SCROLL SAW | SIERRA PARA MARQUETERIA

Code Código	Qty pack Paquete	Description Descripción	For ART. Para ART.	EAN CODE
SS40-605	12	Blade 127x0.55x0.25 - Z 10,7 cm <i>Sierra 127x0,55x0,25 - Z 10,7 cm</i>	SS40-562	8025191302865
SS40-608	12	Blade 127x1.00x0.40 - Z 6,3/cm <i>Sierra 127x1,00x0,40 - Z 6,3/cm</i>		8025191302872
SS40-611	12	Blade 127x1.35x0.46 - Z 5,2/cm <i>Sierra 127x1,35x0,46 - Z 5,2/cm</i>		8025191302889
SS40-615*	12	Blade 127x1.75x0.25 mm - Z6,3 cm with PIN <i>Sierra 127x1,75x0,25 mm - Z6,3 cm con PIN</i>		8025191302247



TABLE SAWS | SIERRAS DE MESA

Code Código	Qty pack Paquete	Description Descripción	For ART. Para ART.	EAN CODE
TR36-534	1	Disk blade Ø 254mm Ø 30mm Z40 <i>Disco Ø 254mm Ø 30mm Z40</i>	TS 36-523	8025191302377



PADDLE MIXERS | MEZCLADORAS

Code Código	Qty pack Paquete	Description Descripción	For ART. Para ART.	EAN CODE
EM 77-010	1	Paddle H.600x120 mm H2 double spiral Varilla H.600x120 mm H2 doble espiral		8025191700982
EM 77-020*	1	Paddle H.600x140 mm H2 double spiral Varilla H.600x140 mm H2 doble espiral		8025191700999
EM 77-030**	1	Paddle H.600x160 mm H2 double spiral Varilla H.600x160 mm H2 doble espiral		8025191701002
EM 77-110	1	Paddle H.600x120 mm H3 triple spiral Varilla H.600x120 mm H3 espiral triple		8025191701019
EM 77-120 **	1	Paddle H.600x140 mm H3 triple spiral Varilla H.600x140 mm H3 espiral triple		8025191701026
EM 77-220	1	Paddle H.600x114 mm H4 double helical spiral Varilla H.600x114 mm H4 double espiral helicoidal		8025191701033
EM 76-000		MIXER'S STAND EXPOSITOR PARA MEZCLADOR		8025191700975

* ** STANDARD FITTING | EN DOTACIÓN ESTÁNDAR

CONSTRUCTION TABLE SAW | SIERRA DE MESA PARA CONSTRUCTION

Code Código	Qty pack Paquete	Description Descripción	For ART. TS 36-528 Para ART. TS 36-528	EAN CODE
TS 36-532	1	Disk blade Ø 315mm z24 Sierra Ø 315mm z24		8025191302742

CHOP SAW | TRONZADORA PARA METAL

Code Código	Qty pack Paquete	Description Descripción	For ART. Para ART.	EAN CODE
CS 20-141	1	Abrasive disk Ø 350x3x25,4mm Disco abrasivo Ø 350x3x25,4mm	CS20-140	8025191302520





05

femi
Job Line



XL
femi
Job Line

METAL WORKING



TRABAJO DE METAL

BANDSAWS FOR METAL CUTTING
SIERRAS DE CINTA



FLEXICUT 1140E

MAX 130 mm



FLEXIBASE



MAGNETIKO

Magnetic chip collector suitable for all bandsaws
Varilla magnética para todas las sierras de cinta.

- Extreme portability
- Ideal for the construction site
- LED light
- Powerful 1100W motor
- Electronic speed regulator
- Easy blade change
- Adjustable handle

- Portabilidad extrema
- Ideal para el sitio de construcción
- Luz LED
- Potente motor 1100W
- Regulación electrónica de la velocidad
- Cambio fácil de la cinta
- Mango ajustable

CUTTING CAPACITY CAPACIDAD DE CORTE

0°	130x120 mm

0°	120 mm

0°	120x120 mm



Use with base
Usa con base



Removable from the working table for flexible operation
Extraíble de la mesa de trabajo para un funcionamiento flexible.

CUTTING CAPACITY MACHINE ON THE BASE CAPACIDAD DE CORTE MAQUINA SOBRE LA BASE

0°	H 95 x L 80 mm L 115 x 18 mm
45°	H 85 x L 10 mm H 58 x L 28 mm

0°	80 mm
45°	40 mm

0°	80 mm
45°	38 mm



Rigid case for transport
(included as standard fitting)
Caja de plástico para el transporte (incluida de serie)



FLEXIBASE

ART.	Code Código	EAN CODE
340	7.13.37.25	8025191701361

Base with vice for bench work (optional)
Base con mordaza para trabajo de mesa (opcional)

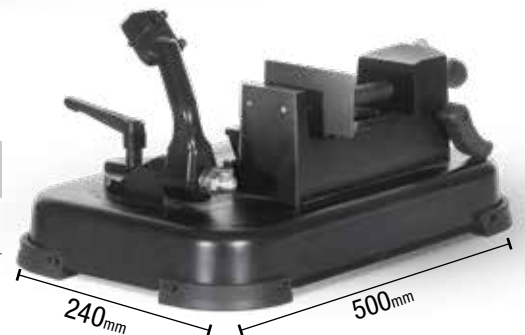

Code Código	EAN CODE
8.47.20.20	8025191806424

Motor power Potencia motor	Blade dimension Medida cinta	Blade teething Dentado	Speed Velocidad	Package dimensions Dimensiones del paquete	Weight Peso
1100 Watt	1140x13x0,65 mm	10/14	0-144	 axb x h	Kg
				600x400x200	9,5

Single phase motor 230 Volt - Hz 50 - Motor monofásico 230 - Hz 50

ART.
SN 105XL



STANDARD EQUIPMENT

- Adjustable bar stop rod
- Spare blade clean felts kit
- EQUIPAMIENTO DE SERIE**
- Varilla tope regulable
- Kit recambio fieltros de limpieza hoja

- Safe and clean dry cutting
- Easy to carry: only 17 Kg
- Max cutting capacity Ø 105 mm
- Powerful 850W motor, 2 speeds electronically switched
- Practical blade tensioning device

- Corte sin lubricación: máxima seguridad y sin tacha
- Fácil de transportar: solamente 9 Kg
- Max capacidad de corte Ø 105 mm
- Potente motor 850 W, dos velocidades de conmutación electrónica
- Tensor de la hoja práctico de usar

**CUTTING CAPACITY
CAPACIDAD DE CORTE**

0°	105x93 mm
45°	70x60 mm

0°	105 mm
45°	72 mm

0°	102x102 mm
45°	68x68 mm



DOWNLOAD THE VIDEO
DESCARGA EL VIDEO



Cutting capacity up to Ø 105 mm
Capacidad de corte hasta Ø 105 mm

Code Código	EAN CODE
8.48.30.22	8025191803416

Motor power Potencia motor	Blade dimension Medida cinta	Blade teething Dentado	Speed Velocidad	Article dimensions Artículo dimensiones	Package dimensions Dimensiones del paquete	Weight Peso
				AxBxC	axbxh	Kg
850 Watt	1335x13x0,65 mm	8/12	60/80 Mt/Min	383x639x282 mm	700x570x330 mm	17

Single phase motor 230 Volt - Hz 50 - Motor monofásico 230 - Hz 50

Bandsaws for metal cutting - Sierras de cinta

- Innovative blade tensioning device with clutch to check and adjust the proper tensioning of the blade (patented)
- Powerful 1200 W universal motor
- Digital electronic speed regulator "Constant Speed" with amperometric limiting device
- Die-cast vice with prismatic guides
- Easy to carry: only 17 Kgs

- *Innovador tensor mediante embrague para el control y la regulación del correcto tensado de la hoja (patentado)*
- *Potente motor universal 1200 W*
- *Regulación electrónica de velocidad "velocidad constante", con limitador amperimétrico y protección térmica*
- *Mordaza moldeada a presión con guías prismáticas*
- *Sólo 17 kg de peso para la máxima portabilidad*

STANDARD EQUIPMENT

- Adjustable bar stop rod
- Filter-circuit for electromagnetic interference damping according to rules in force

EQUIPAMIENTO DE SERIE

- Varilla tope regulable
- Circuito-filtro para la eliminación de interferencias electromagnéticas conforme con las normativas vigentes

**CUTTING CAPACITY
CAPACIDAD DE CORTE**

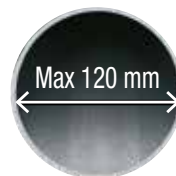

0°	120x115 mm
45°	85x70 mm

0°	120 mm
45°	85 mm

0°	119x119 mm
45°	80x80 mm



Cutting capacity up to \varnothing 120 mm and up to \square 120 x 115 mm
Capacidad de corte hasta \varnothing 120 mm y hasta \square 120 x 115 mm



Powerful motor with digital electronic speed regulator
Potente motor con regulación electrónica de velocidad



Code Código	EAN CODE
8.48.50.24	8025191804680

Motor power Potencia motor	Blade dimension Medida cinta	Blade teething Dentado	Speed Velocidad	Article dimensions Artículo dimensiones	Package dimensions Dimensiones del paquete	Weight Peso
						Kg
				AxBxC	axbxbh	
1200 Watt	1440x13x0,65 mm	8/12	30÷80 Mt/Min	600x850x800 mm	900x400x520 mm	17

Single phase motor 230 Volt - Hz 50 - Motor monofásico 230 - Hz 50

ART.
SN 205XL



STANDARD EQUIPMENT

- Adjustable bar stop-rod for mass-produced cuts (L= 500mm)
- Handles for easy handling
- Filter-circuit for electromagnetic interference damping according to rules in force

EQUIPAMIENTO DE SERIE

- Varilla tope regulable, para realizar cortes en serie (L= 500mm)
- Asas para el transporte
- Circuito-filtro para la eliminación de interferencias electromagnéticas conforme con las normativas vigentes

- Unique and great cutting capacity: \square 205 x 150 mm
- Powerful 1600 Watt motor with two speeds electric switchover and thermal protection
- Blade tensioning system fitted with light indicator
- Easy to carry

- Gran capacidad de corte: \square 205 x 150 mm
- Potente motor 1600 W - dos velocidades de conmutación eléctrica, con protección térmica
- Tensor de la hoja práctico de usar con indicador visual
- Fácil de transportar

**CUTTING CAPACITY
CAPACIDAD DE CORTE**

0°	205x150 mm
45°	105x95 mm

0°	152 mm
45°	106 mm

0°	150x150 mm
45°	102x102 mm



Exclusive "roto-translating" arm system (PATENTED)
Sistema exclusivo del brazo "roto-traslación" (PATENTADO)



Ideal for cutting large profiles like conduits and profiles
Ideal para el corte de grandes perfiles como los conductos y tubulares

Code Código	EAN CODE
8.48.60.27	8025191803744

Motor power Potencia motor	Blade dimension Medida cinta	Blade teething Dentado	Speed Velocidad	Article dimensions Artículo dimensiones	Package dimensions Dimensiones del paquete	Weight Peso
				AxBxC	axbxh	
1600 Watt \square	1735x13x0,9 mm	14	60/80 Mt/Min	800x1080x750 mm	1000x390x570 mm	38

\square Single phase motor 230 Volt - Hz 50 - Motor monofásico 230 - Hz 50

Bandsaws for metal cutting - Sierras de cinta

DIGI MAX LINE



DIGI MAX 13



H 600 mm

Ø 13 mm



DIGI MAX 16B-PRO



H 900 mm

Ø 16 mm



DIGI MAX 16F-PRO



H 1635 mm

Ø 16 mm



METAL WORKING



TRABAJO DE METAL

DRILL PRESSES TALADROS DE COLUMNA

DP 12-961



DP 12-943



DP 12-941



DP 12-921



H 580 mm
Ø 13 mm

H 845 mm
Ø 16 mm

H 1610 mm
Ø 16 mm

H 1700 mm
Ø 20 mm
max 32mm

METAL LATHE | TORNIO PARA METAL

DIGI **TO**
ML350

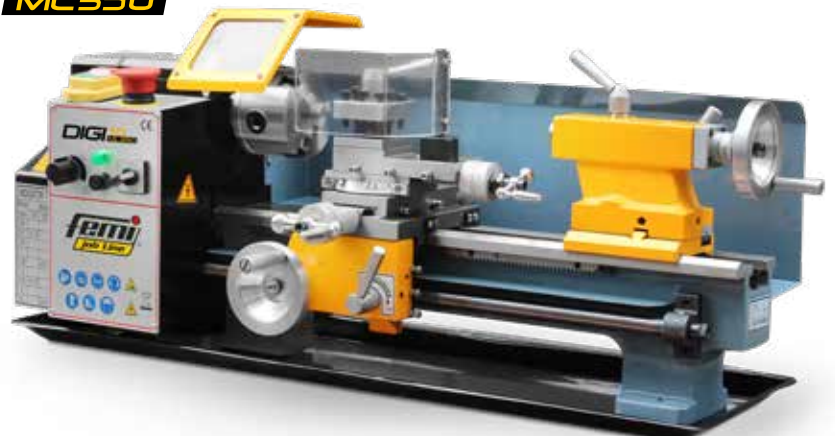

New



MAGNETIKO

Magnetic chip collector suitable for all
drill presses and metal lathe

Varilla magnética por todos taladros de
columna y tornio

- Column diameter 46 mm
- Drilling speed :
Position 1: 220 - 880 min⁻¹
Position 2: 650 - 2550 min⁻¹
- **Cutting speed adjustment with last setting memory function**
- Drilling capacity max 13 mm
- Chuck capacity from 1,5 to 13 mm
- Distance from chuck to base 280 mm
- Height 660 mm
- Workbench - base 340x300x40 mm
- LASER :
 - Class 2
 - Wavelength : 650 nm
 - Power < 1 mW

- *Diametro columna 46 mm*
- *Velocidad de taladro:*
Posicion 1: 220 - 880 min⁻¹
Posicion 2: 650 - 2550 min⁻¹
- **Ajuste de la velocidad de corte con función de memoria del último ajuste**
- *Capacidad de taladro max 13 mm*
- *Capacidad del portabrocas da 1,5 a 13 mm*
- *Distancia portabrocas-base 280 mm*
- *Altura 660 mm*
- *Mesa de trabajo - base 340x300x40 mm*
- **LÁSER:**
 - *Clase2*
 - *Longitud de onda: 650 nm*
 - *Potencia < 1 mW*

STANDARD EQUIPMENT

- Laser pointing device
- Led light
- Quick locking vice

EQUIPAMIENTO DE SERIE

- Puntero Laser
- Luz Led
- Mordaza con bloqueo rápido

**Self locking chuck
13 mm H 660 mm**
**Portabrocas
autobloqueante
13 mm H 660 mm**



Digital display to read speed and drilling depth
Display digital indicador de velocidad y profundidad de perforación



Drilling speed steel: 170-880 min⁻¹
Velocidad de taladro acero: 170-880 min⁻¹



Drilling speed wood: 490-2600 min⁻¹
Velocidad de taladro madera: 490-2600 min⁻¹



**VARIABLE AND ELECTRONIC
SPEED REGULATION**
**REGULACIÓN DE VELOCIDAD
VARIABLE Y ELECTRÓNICA**

bench model
de banco

Code Código	EAN CODE
8.08.61.46	8025191806455

Motor power Potencia motor			Article dimensions Artículo dimensiones	Package dimensions Dimensiones del paquete	Weight Peso
720 Watt	1,5 - 13 mm	220=880 650÷2550	AxBxC	axbxh	Kg
			600x340x300 mm	620x356x255	9,5

Single phase motor 230 Volt - Hz 50 - Motor monofásico 230 - Hz 50

ART.

DIGI MAX
16B-PRO**femi**
job Line**STANDARD EQUIPMENT**

- Chuck protection with safety micro-switch
- Ergonomic handle
- Laser pointing device
- LED light
- Drilling depth indicator

EQUIPAMIENTO DE SERIE

- Protección del portabrocas con microinterruptor de seguridad
- Empunadura ergonómica
- Puntero láser
- Luz LED
- Indicador de profundidad de taladro

- Column diameter: 60 mm
- Chuck stroke: 80 mm (with graduate scale adjusting)
- Chuck capacity: from 1 up to 16 mm
- Self-locking chuck: cone B16
- Chuck connection: MT2
- Distance from chuck to column: 150 mm
- Dilling capacity: 16 mm
- Height: 900 mm
- Workbench: 243x243 mm with extension

- *Diametro columna: 60 mm*
- *Recorrido del porta brocas: 80 mm ajustable con varilla graduada*
- *Capacidad del portabrocas: da 1 a 16 mm*
- *Portabrocas autobloqueante: cono B16*
- *Conexión de portabrocas: MT2*
- *Distancia portabrocas-columna: 150 mm*
- *Capacidad de taladro: 16 mm*
- *Altura: 900 mm*
- *Mesa de trabajo: 243x243 mm con extensión*

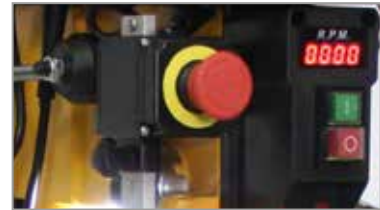
Self locking chuck**16 mm H 900 mm****Portabrocas****autobloqueante****16 mm H 900 mm****bench model
de banco**

Digital display with rotation speed indicator: combined with the speed adjustment function it allows to properly use the press drill according to the materials to be drilled.

Display indicador de velocidad de rotación: combinado con la función de ajuste de velocidad, permite de utilizar el taladro correctamente de acuerdo con los materiales que se perforarán.



Speed adjustment function with external control: great versatility, precision and ease to use.

Función de ajuste de velocidad con control externo, gran versatilidad, precisión y facilidad de uso.



Work table with extension and laser.

Mesa de trabajo con extensión y puntería láser.



Chuck protection with safety microswitch.

Protección del portabrocas con microinterruptor de seguridad.



Code Código	EAN CODE
8.08.61.35	8025191805106

Motor power Potencia motor	RPM			Article dimensions Artículo dimensiones	Package dimensions Dimensiones del paquete	Weight Peso
						Kg
550 Watt	950	3 - 16 mm	390÷2200	950x580x370 mm	760x495x285	42

Single phase motor 230 Volt - Hz 50 - *Motor monofásico 230 - Hz 50*

- Column diameter: 80 mm
- Chuck stroke: 120 mm
- Chuck capacity: from 1 up to 16 mm
- Self-locking chuck: cone B16
- Chuck connection: MT2
- Distance from chuck to column: 215 mm
- Drilling capacity: 20 mm
- Height: 1635 mm
- Workbench: 335x335 mm

- *Diametro columna: 80 mm*
- *Recorrido del porta brocas: 120 mm*
- *Capacidad del portabrocas: da 1 a 16 mm*
- *Portabrocas autobloqueante: cono B16*
- *Conexión de portabrocas: MT2*
- *Distancia portabrocas-columna: 215 mm*
- *Capacidad de taladro: 20 mm*
- *Altura: 1635 mm*
- *Mesa de trabajo: 335x335 mm*

STANDARD EQUIPMENT

- Chuck protection with safety microswitch
- Ergonomic handle
- Light
- Drilling depth indicator

EQUIPAMIENTO DE SERIE

- *Protección del portabrocas con microinterruptor de seguridad*
- *Empuñadura ergonómica*
- *Luz*
- *Indicador de profundidad de taladro*



Digital display with rotation speed indicator: combined with the speed adjustment function it allows to properly use the press drill according to the materials to be drilled.

Display indicador de velocidad de rotación: combinado con la función de ajuste de velocidad, permite de utilizar el taladro correctamente de acuerdo con los materiales que se perforarán.



Speed adjustment function with external control: great versatility, precision and ease to use.

Función de ajuste de velocidad con control externo, gran versatilidad, precisión y facilidad de uso.



Graduated rod for adjusting the drilling depth to assure precise machining and serial jobs.

Varilla graduada para ajustar la profundidad de perforación: para un mecanizado preciso y en serie.



Chuck protection with safety microswitch.

Protección del portabrocas con microinterruptor de seguridad.



**Self locking chuck
16 mm H 1635 mm
Portabrocas
autobloqueante
16 mm H 1635 mm**

**floor model
pedestal mode**

Code Código	EAN CODE
8.08.61.39	8025191806516

Motor power Potencia motor	RPM			Article dimensions Artículo dimensiones	Package dimensions Dimensiones del paquete	Weight Peso
			12 SPEED	AxBxC	axbxh	Kg
1100 Watt	1400	1 - 16 mm	440÷2100	480x380x290 mm	13950x520x245mm	81

Single phase motor 230 Volt - Hz 50 - Motor monofásico 230 - Hz 50

STANDARD EQUIPMENT

- 2 counter bits
- 3 clamps
- Spare gear
- Toolings
- Pipette for lubricating oil

EQUIPAMIENTO DE SERIE

- 2 contra punto
- Portabrocas de 3 pinzas
- Engranaje de repuesto
- Utililajes
- Pipeta para lubricante

- Electronic speed regulation by digital display
- Automatic feed of the longitudinal carriage
- Reversing rotation of the chuck
- Safety protection with microswitch
- Bit and counter bit carriage release movement
- Emergency switch START/STOP
- Bits distance: 350 mm
- Lathe maximum diameter: 180 mm
- Bar passage maximum diameter: 20 mm
- Transversal stroke: max 65 mm
- Vertical stroke: max 35 mm
- Chuck connection: MT3
- Counter bit connection: MT2
- Chuck diameter: 100 mm

- Regulación electrónica de la velocidad con visor digital
- Avance automático del carro longitudinal
- Inversión de la rotación del portabrocas
- Protección de seguridad con microinterruptor
- Mecanismo de liberación rápida del carro punto y contra punto
- Interruptor de emergencia START/STOP
- Distancia entre brocas: 350 mm
- Diámetro de torneado máximo: 180 mm
- Diámetro máximo pasaje de barra: 20 mm
- Recorrido transversal: max 65 mm
- Recorrido vertical: max 35 mm
- Ataque del portabrocas: MT3
- Cono morse contra punto: MT2
- Diámetro del portabrocas: 100 mm



Metal lathe • Tornio para metal







Digital display with chuck rotation speed indicator
Visor digital con indicador de velocidad de la rotación del portabrocas



Working spaces shielding by safety microswitch
Protecciones de la zona de trabajo con microinterruptor de seguridad

Code Código	EAN CODE
8.35.61.21	8025191806462

Motor power Potencia motor	RPM	Article dimensions Artículo dimensiones	Package dimensions Dimensiones del paquete	Weight Peso
		 AxBxC	 axb x h	Kg
450 Watt 	50 – 2500	370x390x740 mm	800x370x420 mm	40

 Single phase motor 230 Volt - Hz 50 - *Motor monofásico 230 - Hz 50*

Drill press bench model · Taladro de columna de banco



bench model
de banco

- Small compact and reliable pillar drill, ideal for small drilling works
- Top cover with safety microswitch
- Safety on/off switch to avoid accidental start
- No-slip handle
- Pequeño tamaño, alta fiabilidad ideal para pequeños trabajos de perforación
- Tapa superior con microinterruptor de seguridad
- Interruptor on/off de seguridad para evitar el arranque accidental
- Empuñadura antideslizante

- STANDARD EQUIPMENT**
- Chuck protection
 - Ergonomic handle
 - Chuck key
- EQUIPAMIENTO DE SERIE**
- Protección del portabrocas
 - Empuñadura ergonómica
 - Llave de bloqueo del portabrocas

Chuck 13 mm H 580 mm
Portabrocas 13 mm H 580 mm

TECHNICAL FEATURES

- Column diameter: 46 mm
- Chuck stroke: 50 mm
- Key chuck capacity: 1,5-13 mm
- Chuck connection: B16
- Distance from chuck to column: 104 mm
- Drilling capacity: 13 mm
- Height: 580 mm
- Workbench: 162x154 mm

CARACTERÍSTICAS TÉCNICAS

- Diámetro columna : 46 mm
- Recorrido del porta brocas: 50 mm
- Capacidad del portabrocas: 1,5-13 mm
- Portabrocas: B16
- Distancia del portabrocas a la columna: 104 mm
- Capacidad de taladro: 13 mm
- Altura: 580 mm
- Mesa de trabajo: 162x154 mm



500 Watt Powerful motor
Potente motor 500 watt



Graduated rod for drilling depth adjustment
Varilla graduada para ajustar la profundidad de perforación

Code Código	EAN CODE
8.08.61.28	8025191805281

Motor power Potencia motor	RPM	Article dimensions Artículo dimensiones	Package dimensions Dimensiones del paquete	Weight Peso
500 Watt	1490	 580x195x295 mm	 470x380x250	Kg 18

Single phase motor 230 Volt - Hz 50 - Motor monofásico 230 - Hz 50



bench model
de banco

- Drill suitable for those looking for performance and compactness
- Key chuck capacity from 3 up to 16 mm
- Tilting workbench
- 3 Arms knob for a leverage effect in every moment
- Adjustable drilling table height without tools
- El taladro para aquellos que buscan rendimiento y compactidad
- Capacidad del portabrocas con llave de 3 a 16 mm
- Mesa de trabajo inclinable
- Perilla a 3 brazos para un efecto palanca en cualquier momento
- Altura mesa de perforación ajustable sin instrumentos

- STANDARD EQUIPMENT**
- Chuck protection
 - Ergonomic handle
 - Chuck key
- EQUIPAMIENTO DE SERIE**
- Protección del portabrocas
 - Empuñadura ergonómica
 - Llave de bloqueo del portabrocas

Chuck 16 mm H 845 mm
Portabrocas 16 mm H 820 mm

TECHNICAL FEATURES

- Column diameter: 60 mm
- Chuck stroke: 80 mm
- Key chuck capacity: 3-16 mm
- Chuck connection: B16
- Distance from chuck to column: 126 mm
- Drilling capacity: 16 mm
- Height: 845 mm
- Workbench: 202x197 mm

CARACTERÍSTICAS TÉCNICAS

- Diámetro columna : 60 mm
- Recorrido del porta brocas: 80 mm
- Capacidad del portabrocas: 3-16 mm
- Portabrocas: B16
- Distancia del portabrocas a la columna: 126 mm
- Capacidad de taladro: 16 mm
- Altura: 845 mm
- Mesa de trabajo: 202x197 mm



Upper cover opening with safety microswitch
Tapa superior con micro-interruptor de seguridad



Workbench height adjustment thanks to a rack
Mesa de trabajo ajustable gracias al mecanismo de cremallera

Code Código	EAN CODE
8.08.61.24	8025191805298

Motor power Potencia motor	RPM	Article dimensions Artículo dimensiones	Package dimensions Dimensiones del paquete	Weight Peso
460 Watt	1400	 840x195x330 mm	 680x420x245mm	Kg 27

Single phase motor 230 Volt - Hz 50 - Motor monofásico 230 - Hz 50

ART. **DP 12-943**

STANDARD EQUIPMENT

- Chuck protection
- Ergonomic handle
- Chuck key

EQUIPAMIENTO DE SERIE

- Protecció del portabrocas
- Empuñadura ergonòmica
- Llave de bloqueo del portabrocas

- Drill press reliable and essential with large drilling capacity
- 3 Arms knob for a leverage effect in every moment
- Adjustable drilling table height without tools

- Taladro fiable y esencial de gran capacidad de perforación
- Perilla a 3 brazos para un efecto palanca en cualquier momento
- Altura mesa de perforación ajustable sin instrumentos

Chuck 16 mm H 1610 mm
Portabrocas 16 mm H 1610 mm



360° tilting workbench
Mesa de trabajo inclinable a 360°



Induction motor
Motor a inducción

TECHNICAL FEATURES

- Column diameter: 70 mm
- Chuck stroke: 80 mm
- Key chuck capacity: 3-16 mm
- Chuck cone: MT2
- Chuck connection: 16
- Distance from chuck to column: 170 mm
- Drilling capacity: 16 mm
- Height: 1610 mm
- Workbench: 255x255 mm

CARACTERÍSTICAS TÉCNICAS

- Diámetro columna: 70 mm
- Recorrido del porta brocas: 80 mm
- Capacidad del portabrocas: 3-16 mm
- Cono de portabrocas: MT2
- Conexión de portabrocas: 16
- Distancia del portabrocas a la columna: 170 mm
- Capacidad de taladro: 16 mm
- Altura: 1610 mm
- Mesa de trabajo: 255x255 mm

floor model
pedestal mode



Drill press floor model · Taladro de columna pedestal mode

Code Código	EAN CODE	Motor power Potencia motor	RPM			Article dimensions Artículo dimensiones	Package dimensions Dimensiones del paquete	Weight Peso
						Ax BxC	axbxh	Kg
8.08.61.25	8025191805304	460Watt	1400	3-16 mm	180 - 2740	480x380x290 mm	1500x500x270	46

Single phase motor 230 Volt - Hz 50 - *Motor monofásico 230 - Hz 50*

STANDARD EQUIPMENT

- Chuck protection
- Ergonomic handle
- Chuck key

EQUIPAMIENTO DE SERIE

- PProtecció del portabrocas
- Empuñadura ergonòmica
- Llave de bloqueo del portabrocas

ART. **DP 12-961**

- Stability and power, robustness and reliability
- Distance from chuck to column 257 mm
- Safety on/off switch to avoid accidental start
- Stable working table with vice fixing holes
- Estabilidad y potencia, robustez y fiabilidad
- Distancia del portabrocas a la columna 257 mm
- Interruptor on/off de seguridad para evitar el arranque accidental
- Base de trabajo estable con agujeros de fijación para mordaza

Chuck 20 mm H 1700 mm
max drill 32 mm
Portabrocas 20 mm H 1700 mm
taladro max 32 mm



Chuck protection
Protección del portabrocas



Sturdy coupling between the base and column (column diameter 92 mm)
Acoplamiento robusto entre la base y la columna (diámetro de la columna 92 mm)

TECHNICAL FEATURES

- Column diameter: 92 mm
- Chuck stroke: 120 mm
- Key chuck capacity: 3-20 mm
- Chuck cone: B22
- Chuck connection: MT3
- Drilling capacity: 32 mm
- Height: 1700 mm
- Workbench: 395x425 mm

CARACTERÍSTICAS TÉCNICAS

- Diámetro columna : 92 mm
- Recorrido del porta brocas: 120 mm
- Capacidad del portabrocas: 3-20 mm
- Cono de portabrocas: B22
- Conexión de portabrocas: MT3
- Capacidad de taladro: 32 mm
- Altura: 1700 mm
- Mesa de trabajo: 395x425 mm

floor model
pedestal model



Code Código	EAN CODE	Motor power Potencia motor	RPM			Article dimensions Artículo dimensiones	Package dimensions Dimensiones del paquete	Weight Peso
						Ax BxC	axbxh	Kg
8.08.61.26	8025191805564	1100 Watt	1400	3-20 mm	200-1990 mm	1700x400x590 mm	1150x650x310 650x520x320	116

Single phase motor 230 Volt - Hz 50 - *Motor monofásico 230 - Hz 50*

SMARTY

Folding Table

TECHNICAL FEATURES

- Table width: 990 mm
- Maximum rollers extension from the table: 450 mm
- Maximum width with extensions: 1890 mm
- Maximum rollers height from the table: 175 mm
- Table height from the ground: 835 mm
- Maximum charge: 100 kg

Banco plegable

CARACTERÍSTICAS TÉCNICAS

- Ancho de la mesa: 990 mm
- Extensión máxima de los rodillos de la mesa: 450 mm
- Ancho máximo con extensiones: 1890 mm
- Altura máxima de los rodillos de la mesa: 175 mm
- Altura de la mesa desde el suelo: 835 mm
- Máx posibilidad de carga: 100 kg

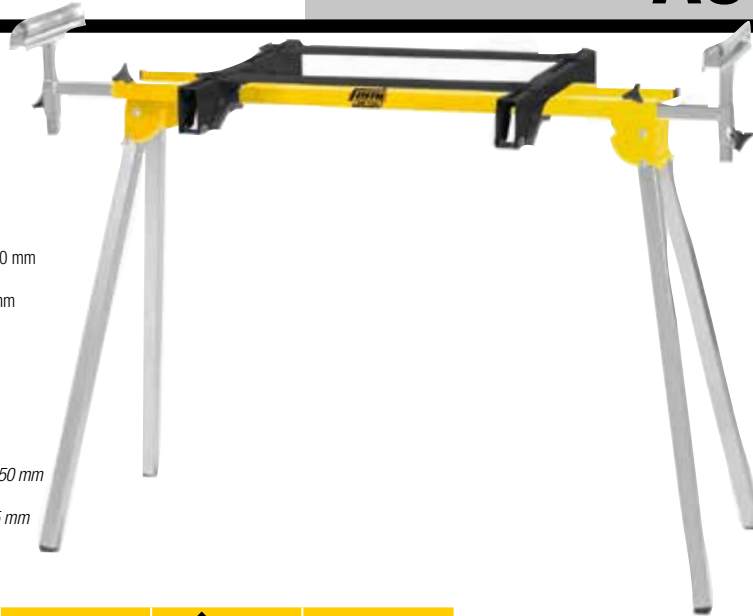

Steel legs with "push and click" fixing system. Adjustable and removable universal brackets for fixing different sized machinery.

Patatas de acero con sistema de fijación "push and click". Soportes universales ajustables y desmontables para el fijaje de máquinas de distintos tamaño.



ART. F50-179 CL

Additional kit of brackets for quick fixing
Kit soportes de fijación

ART.	Code Código	EAN CODE	axbxh	Weight Peso
330	7.13.37.08	8025191805595	1070x220x150	15 Kg

ART.	EAN CODE
F50-179 CL	8025191701279

New MAGNETIKO

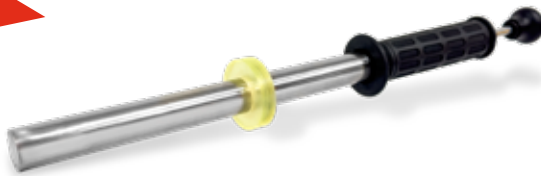

TECHNICAL FEATURES

- Magnetic chip collector with ergonomic handle
- Stainless and lightweight shaft
- Ideal to reach hard areas
- To collect metal chips, nails and small metal components from chip-releasing machinery
- By extracting the central bar you can easily release the collected metal parts

CARACTERÍSTICAS TÉCNICAS

- Varilla magnética con mango ergonómico
- Eje inoxidable y liviano
- Ideal para zonas de difícil acceso
- Para recoger virutas de metal, clavos y pequeños componentes metálicos de la maquinaria liberadora de virutas.
- Extrayendo la barra central podrás liberar fácilmente las piezas metálicas recogidas



Code Código	EAN CODE	Size Dimensiones	Weight Peso
7.07.51.95	8025191701477	435 mm - Ø 20 mm	650 gr

Work Table Kit

TECHNICAL FEATURES

- Alluminium work table with goniometer guides
- Equipped with anti-tips support
- Quick and easy assembly

Kit mesa de trabajo

CARACTERÍSTICAS TÉCNICAS

- Mesa de aluminio con guías para goniómetro
- Apoyo contra vuelcos
- Montaje simple y rápido



Code Código	EAN CODE
7.07.51.72	8025191803676

Goniometer for work table

CUTTING ANGLE
ADJUSTMENT
0°-60° right-left



Goniómetro para mesa de trabajo

REGULACION DE ÁNGULO 0°-60° de-iz

Code Código	EAN CODE
5.13.07.52	8025191700081

Single-roller support

TECHNICAL FEATURES

- Zinc-plated steel roller Ø 57 mm
- Sturdy steel structure
- Base equipped with leveling feet
- Support height adjustment
- Maximum charge 30 Kg

Soporte mono-rodillo

CARACTERÍSTICAS TÉCNICAS

- Rodillo de acero galvanizado Ø 57 mm
- Robusta estructura de acero, hierro fundido
- Base provista de pies de nivelación
- Regulación de la altura de apoyo
- Máx posibilidad de carga 30 Kg

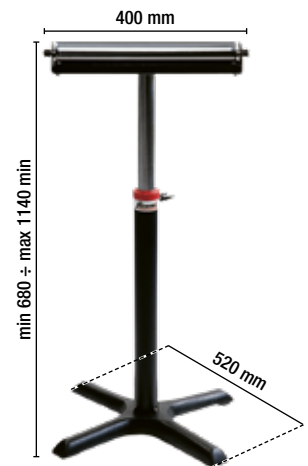

ART.	Code Código	EAN CODE	axbxh	Weight Peso
301	7.13.37.16	8025191806035	450x450x125	6,5 Kg

JOBBY

Folding Table

TECHNICAL FEATURES

- Foldable for easy handling
- Sturdy steel section structure
- Height adjustable in three positions
- Maximum charge 50 Kg

Banco plegable

CARACTERÍSTICAS TÉCNICAS

- Plegable para un fácil transporte
- Estructura de perfil de acero robusto
- Altura regulable en tres posiciones
- Máx posibilidad de carga 50 Kg



ART.	Code Código	EAN CODE
300 Plus	7.13.36.48	8025191700739

BIMETAL BANDSAW BLADES | HOJAS DE CINTA BIMETÁLICAS

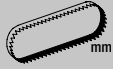
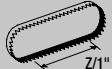
Code Código	Qty pack Paquete	 mm	 Z1"	For ART. Para ART.	EAN CODE
3.29.00.14	1	1140x13x0,65	10/14*	FLEXICUT 1140E	8025191303190
3.29.00.17	5	1140x13x0,65	10/14*		8025191303206
3.29.00.15	1	1140x13x0,65	8/12		8025191303213
3.29.00.18	5	1140x13x0,65	8/12		8025191303220
3.29.00.16	1	1140x13x0,65	18		8025191303237
3.29.00.19	5	1140x13x0,65	18		8025191303324
3.28.99.48	1	1335x13x0,65	8/12*	SN 105XL	8025191301912
3.27.99.20	5	1335x13x0,65	8/12*		8025191300090
3.28.99.49	1	1335x13x0,65	6		8025191301929
3.27.99.21	5	1335x13x0,65	6		8025191300120
3.28.99.18	1	1335x13x0,65	14		8025191301936
3.27.99.22	5	1335x13x0,65	14		8025191300106
3.28.99.19	1	1335x13x0,65	18	SN 120XL	8025191301943
3.27.99.23	5	1335x13x0,65	18		8025191300113
3.29.00.00	1	1440x13x0,65	8/12*		8025191802969
3.29.00.04	5	1440x13x0,65	8/12*		8025191803003
3.28.99.99	1	1440x13x0,65	14		8025191802952
3.29.00.03	5	1440x13x0,65	14		8025191802990
3.29.00.01	1	1440x13x0,65	6	SN 205XL	8025191802976
3.29.00.05	5	1440x13x0,65	6		8025191803010
3.29.00.02	1	1440x13x0,65	18		8025191802983
3.29.00.06	5	1440x13x0,65	18		8025191803027
3.28.99.25	1	1735x13x0,9	14*		8025191301868
3.27.99.28	5	1735x13x0,9	14*		8025191300175
3.28.99.24	1	1735x13x0,9	6/10	SN 205XL	8025191301844
3.27.99.27	5	1735x13x0,9	6/10		8025191300168
3.28.99.26	1	1735x13x0,9	6		8025191301851
3.27.99.29	5	1735x13x0,9	6		8025191300182

*Standard fitting on bandsaws - En dotación estándar en las SIERRA

ACCESSORIES FOR DRILL PRESSES | ACCESORIOS FOR TALADROS DE COLUMNA

Code Código	Qt.à conf. Qt.é paquet	Description Description	For ART. Para ART.	EAN CODE
DP12-906	1	Vice capacity 55 mm <i>Abertura mordaza 55 mm</i>	Digimax 16B PRO Digimax 16F PRO DP 12-921 DP 12-941 DP 12-943 DP 12-961 DP 12-942 Pro Display DP 12-954 Pro Display 	8025191700968
DP12-900	1	Vice capacity 80 mm <i>Abertura mordaza 80 mm</i>		8025191803157
DP12-901	1	Vice capacity 100 mm <i>Abertura mordaza 100 mm</i>		8025191803164
DP12-902	1	Vice capacity 135 mm <i>Abertura mordaza 135 mm</i>		8025191803171
DP12-903	1	Self-locking chuck B16 1,5/13 mm <i>Portabrocas autobloqueante B16 1,5/13 mm</i>		8025191803188
DP12-904	1	Self-locking chuck B16 3/16 mm <i>Portabrocas autobloqueante B16 3/16 mm</i>		8025191803195
DP12-905	1	Self-locking chuck B22 5/20 mm <i>Portabrocas autobloqueante B22 5/20 mm</i>		8025191803201
DP12-909	1	Key chuck B22 5/20 mm <i>Portabrocas con llave B22 5/20 mm</i>		8025191302193
DP12-910	1	Vice wedge MT2-B16 <i>Como morse MT2-B16</i>		8025191302209
DP12-912	1	Vice wedge MT3-B16 <i>Como morse MT3-B16</i>		8025191302223
DP12-913	1	Wedge reduction MT3-MT2 (Only for DP12-961) <i>Reducción como MT3-MT2 - (Solo para DP12-961)</i>		8025191302230

ACCESSORIES FOR METAL LATHE DIGITO ML 350 | ACCESORIOS PARA TORNO DIGITO ML 350

Code Código	Description Description	EAN CODE
3.61.20.10	Lathe tools set 10 mm - 11 pcs <i>Set herramientas 10mm - 11 unidades</i>	8025191303336
3.81.11.03	Rotary live center <i>Contropunta de centrado con balero</i>	8025191303343
3.61.20.11	Quick change tool post <i>Soposte para herramientas con cambio rapido</i>	8025191303350
3.72.10.81	Precision chuck 80 mm - 4 independent jaws <i>Mandril 80 mm 4 mordazas independientes</i>	8025191303367
3.72.10.82	Precision chuck 100 mm - 4 independent jaws with fixing plate <i>Mandril 100mm 4 mordazas independientes con placa de fijacion</i>	8025191303374
3.72.10.83	Precision self centering chuck 100 mm - with fixing plate <i>Mandril 100mm autocentrante con placa de fijacion</i>	8025191303381
3.81.21.02	Dead center MT2 <i>Punta fija como MT2</i>	8025191303398
3.81.21.03	Dead center MT3 <i>Punta fija como MT3</i>	8025191303404





Become a Job Line shop! ¡Conviértete en una tienda Job Line



cod. 7.13.36.72

Metal display weight 30 kg
Maximum charge of each shelf: 30 kg
Maximum charge of bottom base: 35 kg.

*Expositor metal peso: 30 kg
Máxima posibilidad de carga de los estantes: 30 kg
Máxima posibilidad de carga de la base: 35 kg*

cod. 7.13.36.94

Cardboard panel
Panel de cartón
To show
BANDSAWS
MITERSAWS
PLANER & THICKNESSER
*Para demostrar
SIERRAS DE CINTA
TRONZADORAS CEPILLADO
DE SUPERFICIE Y DE ESPESOR*



GRINDY

cod. 7.13.36.96

Display Column in bended steel metal for display bench grinders and sharpening machines
Base expositora de acero laminado para la exhibición de esmeriladoras y afiladora

*Size dimensions :
1450x500x300
Weight: 13 kg*



cod. 0000825

Expo Banner with support frame
50 x 150 cm

*Expo Banner con marco de soporte
50 x 150 cm*



cod. 0000831

Carton Oval for Job Line corner
47 x 140 cm

*Óvalo de cartón para la esquina de la línea de trabajo
47 x 140 cm*



cod. 0000830

FLAG Drop for
Job Line shop 75 x 170 cm

*BANDERA para tienda
Job Line 75 x 170 cm*



cod. 0000827

Micro-perforated banner
for advertising 150 x 75 cm

Banner microperforado
para publicidad 150 x 75 cm



cod. 0000829

Job Line Mat for the shop
corner 120 x 85 cm

Tapete Job Line para tienda
120 x 85 cm



cod. 0000826

TOTEM for Expo Corner
200 x 45 x 45 cm

TOTEM para Expo Corner
200 x 45 x 45 cm

Create your exhibition space with Job Line tools

Crea tu espacio de exhibición con las herramientas de Job Line





FEMI SpA

Via del Lavoro, 4

40023 Castel Guelfo (BO) · ITALY

Tel. +39 0542 487611

infocom@femi.it

www.femi.it



FEMI France Sarl

58, Avenue des Bruyères

69150 Décines · FRANCE

Tel : +33 (0) 4 - 78702778

femifrance@femi.it

www.femi.it/fr